



ENGINE COMPLETION CATALOG



The engine company.

Engine Completion Kit Index

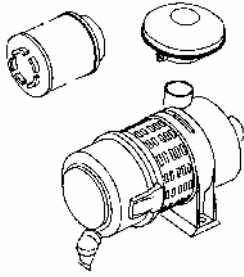

Air Cleaners / Attachments
Page 1-4

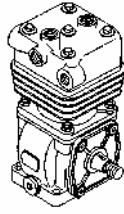

Air Compressors
Page 5-7

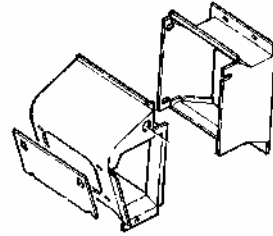

Air Discharge Ducting
Page 8

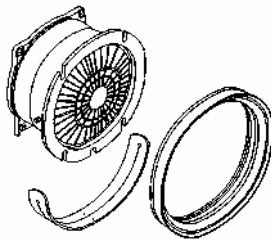

Air Intake Guide Ring
Page 9

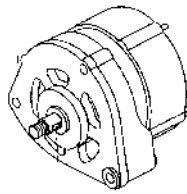

Alternators
Page 10-12

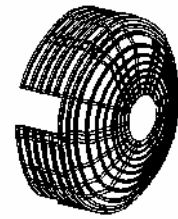

Blower Guards
Page 12

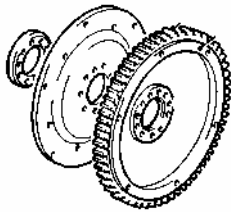

Flywheels
Page 12-14

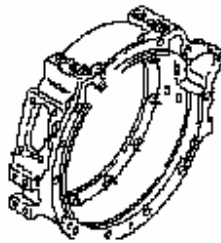

Housings
Page 15-16

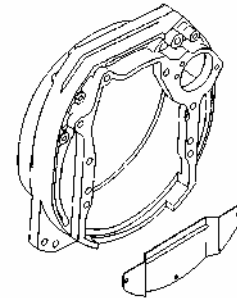

Housing Dust Cover
Page 16

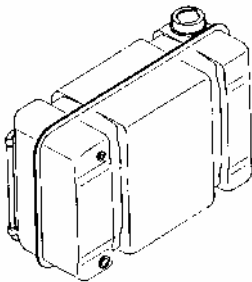

Fuel Tanks
Page 17



Fuel Filters / Fittings
Page 17

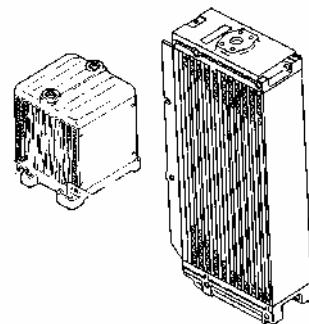

Hydraulic Oil Coolers
Page 18-19

Engine Completion Kit Index

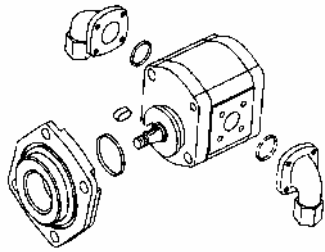

Hydraulic Oil Pumps
Page 19-22

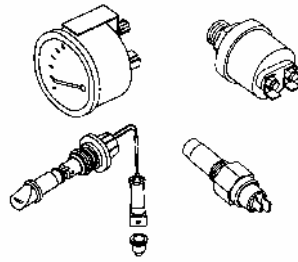

Switches, Sensors, Gauges
Page 23-25

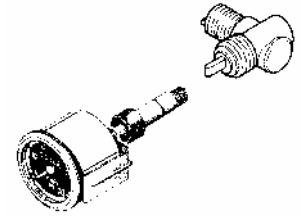

Tach/ Hourmeter/Angle Drive
Page 25

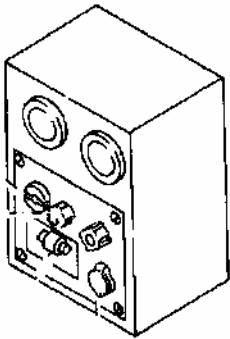

Panels / Safety Shutdown
Page 25-26



Lifting Eyes
Page 27

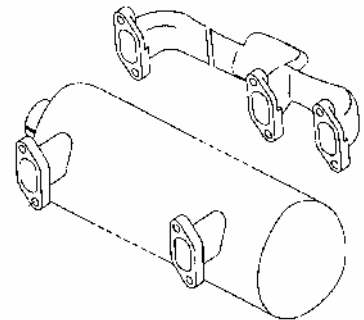

Manifolds / Mufflers
Page 27-31

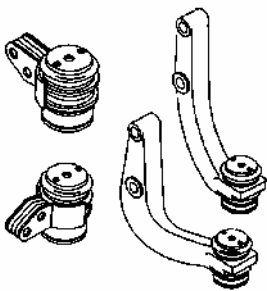

Engine Mounts
Page 32

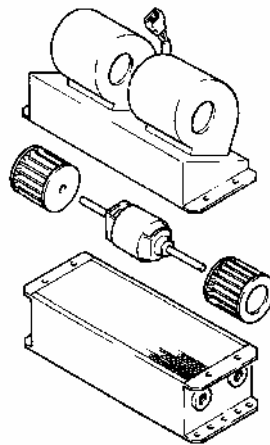

Oil-To-Air Cab Heaters
Page 33

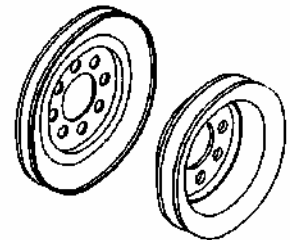

Pulleys / Drives
Page 33

Engine Completion Kit Index

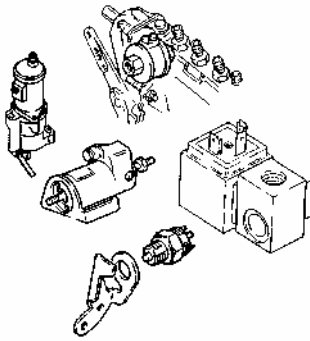

Shutdown Systems
Page 34-35

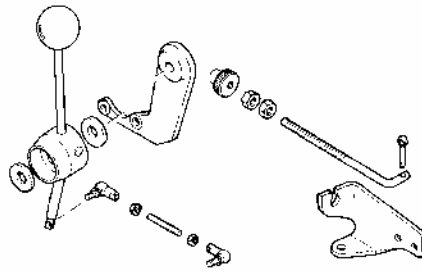

Speed Control
Page 36

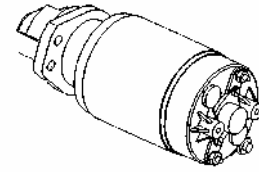

Starters
Page 37

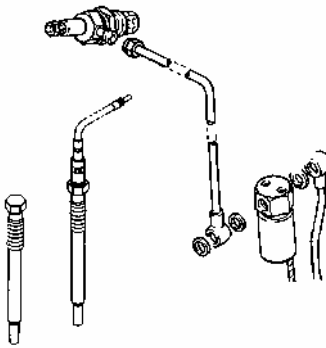

Starting Aids
Page 37-39

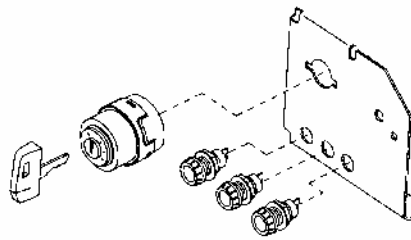

Starting Accessories
Page 39

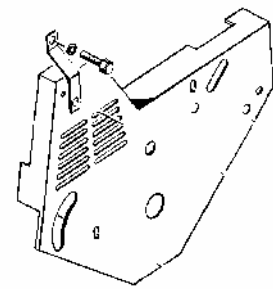

V-Belt Guards
Page 40



Wiring Counter plugs
Page 41



Remote Oil Filter
Page 33



Stubshafts
Page 40



Clutch PTO
Page 45



Engine Heaters / Oil Pans
Page 41

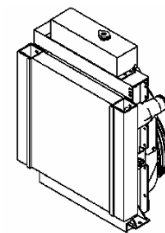

Radiators
Page 42-44

SECT. 1.1 AIR CLEANER, OIL BATH, ENGINE MOUNTED

ENGINE MODEL	KIT # / CODE	ETL PAGE	REMARKS
F3-6L 913	027-0463 SPL	05003499 05050413	4.8 CU. METER/MINUTE, PRECLEANER NOT INCLUDED, TOP AIR INLET, FOR ENGINES WITH INTAKE OPENING AT BLOWER END
F3-6L 913	027-0465 SPL	05003499 05003403	4.8 CU. METER/MINUTE, PRECLEANER NOT INCLUDED, SIDE AIR INLET, FOR ENGINES WITH INTAKE OPENING AT BLOWER END
F3-6L914 / D914 L3,4,5,6	027-7375 SPL	05003503 05079466	4.8 CU. METER/MINUTE, PRECLEANER NOT INCLUDED. CANNOT USE WITH MOUNTED AIR COMP.
F3-6L914 / D914 L3, L4	027-7374 SPL	05075055 05069131	FOR ENGINES WITH AIR COMPRESSOR 05075051 , 05079585
F6L 913	027-0556 SPL	05003504 05023330	5.6 CU. METER/MINUTE, PRECLEANER NOT INCLUDED, SIDE AIR INLET, FOR ENGINES WITH INTAKE OPENING AT BLOWER END
F5-6L914 / BF4L914 / D914 L6	027-0495 SPL	05003504 05003520	5.6 C.U. LOOSE SIDE MOUNT 05003521
F5-6L914 / D914 L5, L6	027-7451 SPL	05003504 05079606	5.6 CU. METER/MINUTE, PRECLEANER NOT INCLUDED. CANNOT USE WITH MOUNTED AIR COMP.
BF6L 913/C	027-2466 SPL	05003954 05018901 05023350	9.6 CU. METER/MINUTE (CANNOT USE WITH SA 27-2595 GUARD); INCLUDES PRECLEANER 05006618, 05003965, 05006620
BF6L914C / TCD914 L6	027-7362 SPL	05003954 05018901 05006618 05003965	FOR ENGINES EQUIPPED WITH FRONT TURBO 9.6 CU. METER/MINUTE (CANNOT USE WITH ALUMINUM V-BELT GUARD); INCLS. PRECLEANER 05006620, 05079573
F5-6L914 / BF4L914	027-0495 SPL	05003504 05003520	LOOSE, SIDE MOUNT 05003521
F6L 913	027-2451 SPL	05003956 05050265	LOOSE, LATERAL AIR INLET
BF6L 913 SP/CSP	027-2465 SPL	05004825 05023349 05050265	COMBINATION-TYPE AIR CLEANER, PAPER ELEMENT,PRE-CLEANER, SUPPLIED LOOSE 05003743, 05050617

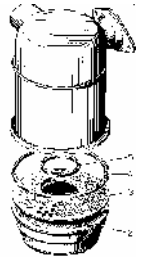

SECT. 1.2 AIR CLEANER, DRY TYPE, ENGINE MOUNTED

ENGINE MODEL	KIT # / CODE	ETL PAGE	REMARKS
F6L 913	027-6487 SPL	05075053 05075050	6.0 CU. METER/MINUTE, W/OUT SERVICE
F5-6L914	027-7367 SPL	05075053 05079579	INDICATOR, W/ RAIN CAP, FOR ENG. EQUIPPED
F3-4L914	027-7368 SPL	05075055 05069131 05079579	WITH INTAKE OPENING AT BLOWER END AND WITHOUT FRONT MOUNTED AIR COMPRESSOR
F3L-4L914 / D914 L3, L4	027-7476 SPL	05075052 05069129 05079587	4.5 CU. METER/MINUTE, W/OUT FRONT MTD. AIR COMPRESSOR

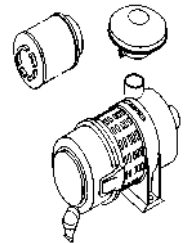

SECT. 1.2 (CONTINUED) AIR CLEANER, DRY TYPE, ENGINE MOUNTED

ENGINE MODEL	KIT # / CODE	ETL PAGE	REMARKS
F3-4L 913	027-6481	05075052 05075049 05069129	4.5 CU. METER/MINUTE, W/ RAIN CAP, W/OUT SERVICE INDICATOR, FOR ENGINES EQUIPPED WITH INTAKE OPENING AT BLOWER END AND WITHOUT FRONT MOUNTED AIR COMPRESSOR
F5/6L914- BF4/6L914 F4-F6L913 / D914 L4,5,6	027-6484	05074534 05069131 05075051	COMBINATION, AIR FILTER 6.0 CCM W/O FASTENING PARTS, W/ SAFETY CARTRIDGE
F6L 913	027-0498 SPL	05005856 05023301 05005853	6.2 C.U. PER MINUTE COMBINATION TYPE AIR CLEANER, PAPER ELEMENT, PRE-CLEANER SUPPLIED LOOSE
F6L913	027-1565 SPL	05023305 05003959 05050265	COMBINATION TYPE AIR CLEANER, PAPER ELEMENT, PRE-CLEANER SUPPLIED LOOSE
ALL 2011	999-0216 SPL	05067563	AIR INTAKE SOUND RESONATOR , FOR USE WITH AIR CLEANER 2200-0489, PN 417-6677
F2-4L/M2011 D/TD2011 L / L I / W	2200-0489	05051642 05063015	4.5 CU. METER/MINUTE, CANNOT USE WITH FRONT MOUNTED FAN OR AIR COMPRESSOR WITHOUT SAFETY ELEMENT OR SERVICE INDICATOR
D2009L4	3101-0399 SPL	05112042	5.25" MOUNTED ACROSS SAE 5 FLYWHEEL HOUSING FOR USE BELOW 1800 RPM (W/OUT SERVICE INDICATOR)
D2009L3	3101-0400 SPL	05112042	5.25" MOUNTED ACROSS SAE 5 FLYWHEEL HOUSING FOR USE BELOW 1800 RPM (W/OUT SERVICE INDICATOR)
D2008L4	3101-0101 SPL		5.25" MOUNTED ACROSS SAE 5 FLYWHEEL HOUSING FOR USE BELOW 1800 RPM (W/OUT SERVICE INDICATOR)
D2008L3	3101-0402 SPL	05112151	5.25" MOUNTED ACROSS SAE 5 FLYWHEEL HOUSING FOR USE BELOW 3000 RPM (W/OUT SERVICE INDICATOR)
D2008L4	3101-0410 SPL	05112208	(6.5" METAL) MOUNT ACROSS SAE 5 FLYWHEEL HOUSING ABOVE 1800 RPM (W/OUT SERVICE INDICATOR)
D2009L4	3101-0411 SPL	05112153	(6.5" METAL) MOUNT ACROSS SAE 4 FLYWHEEL HOUSING FOR 1800 TO 2800 RPM (W/OUT SERVICE INDICATOR)
D2009L3	3101-0412 SPL	05112153	(6.5" METAL) MOUNT ACROSS SAE 4 FLYWHEEL HOUSING FOR 1800 TO 2800 RPM (W/OUT SERVICE INDICATOR)
D2008L4	3101-0413 SPL		(6.5" METAL) MOUNT ACROSS SAE 4 FLYWHEEL HOUSING ABOVE 1800 RPM (W/OUT SERVICE INDICATOR)
D2009L4	3101-0414 SPL	05112071	7" MOUNT ACROSS SAE 5 FLYWHEEL HOUSING ABOVE 1800 RPM (W/OUT SERVICE INDICATOR)
TD2009L4	3101-0416 SPL	05112082	7" MOUNT ACROSS SAE 5 FLYWHEEL HOUSING BELOW 3000 RPM (W/OUT SERVICE INDICATOR)
D2009L4	3101-0417 SPL	05112152	7" MOUNT ACROSS SAE 4 FLYWHEEL HOUSING ABOVE 1800 RPM (W/OUT SERVICE INDICATOR)

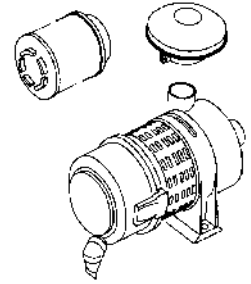

SECT. 2.1 AIR CLEANER, DRY TYPE, REMOTE MOUNTED

ENGINE MODEL	KIT # / CODE	ETL PAGE	REMARKS
B/F4-6L913/C / D914 L4,5,6 F5/6L914 - BF4/6L914	027-6484	05074534 05069131 05075051	6.0 CU. METER/MINUTE, WITH RAIN CAP W/OUT SERVICE INDICATOR 05075095
BF4L913 - BF6L913/C BF4/6L914/C	027-6491 SPL	05003521 05075051	8.0 CU. METER/MINUTE, WITH SAFETY CARTRIDGE 05075057, 05003520, 05075149
BF6L914/C / TCD914 L6	027-6495 SPL	05075051 05050265	12.0 CU. METER/MINUTE 05075119, 05075186
F3-4L 913/914	027-6490 SPL	05074111 05069131 05075051	6.0 CU. METER/MINUTE, WITHOUT SERVICE INDICATOR, W/ SAFETY ELEMENT AND RAIN CAP. 05075095
ALL 1013/E / 2012/2013	029-0843 SPL	05074526	12.0 CU. METER/MINUTE, WITHOUT SERVICE INDICATOR, WITH SAFETY ELEMENT
ALL 1013/E / 2012	029-1460 SPL	05074525	8.0 CU. METER/MINUTE, WITHOUT SERVICE INDICATOR, WITH SAFETY ELEMENT
ALL 1013/E / 2012	029-1629 SPL	05023349 05004827	15.0 CU. METER/MINUTE, WITHOUT SERVICE INDICATOR, WITH SAFETY ELEMENT
FL 2011 / D2011 L2 / L3 / I	2200-0302	05022914	4.2 CU. METER/MINUTE, W/O SERVICE (PICLON) INDICATOR, W/ SAFETY ELEMENT.
FL 2011 / D2011 L2 / L3 / I	2200-0303 SPL	05022915	6.2 CU. METER/MINUTE, W/O SERVICE (PICLON) INDICATOR W/ SAFETY ELEMENT.
B/F4L/M2011	2200-0880 SPL	05023303	6.2 CU. METER/MINUTE, WITH SAFETY (PICLON) SAFETY ELEMENT, W/O SERVICE INDICATOR
FL 2011 / D2011 L2 / L3 / I	2200-2179 SPL	05069128 05069134	3 M ³ /MIN, W/ SAFETY ELEMENT, W/O INDICATOR
FL 2011 / D2011 L2 / L3 / I	2200-2180 SPL	05074110 05069133	4.5 M ³ /MIN, W/ SAFETY ELEMENT, W/O INDICATOR (EUROPICLON)
BF3/4L2011 D/ TD2011 L4 I / W	2200-2183 SPL	05069132 05074534	6.0 M ³ /MIN, W/ SAFETY ELEMENT, W/O INDICATOR (EUROPICLON)
FL 2011 / D2011 L3 / I	2200-2181 SPL	05074111 05069132	6.0 M ³ /MIN, W/ SAFETY ELEMENT, W/O INDICATOR (EUROPICLON)
BF4L2011 D/TD2011 L4 I / W	2200-2182 SPL	05069133 05074112	4.5 M ³ /MIN, W/ SAFETY ELEMENT, W/O INDICATOR (EUROPICLON)

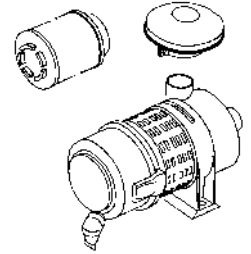

SECT. 2.2 PRECLEANERS, RAIN CAPS

ENGINE MODEL	KIT # / CODE	ETL PAGE	REMARKS
B/F3-6L 913/C / D914 L6 F6L914 / BF4L914 F3-6L913	027-0588 SPL 027-0600 SPL	05069540 05069540 05005858	RAIN CAP FOR 5.6 OR 4.8 CU. METER/MINUTE AIR CLEANER RAIN CAP WITH ELBOW
B/F3-6L 913/C / D914 L3,4,5,6	027-0589 SPL	05069131	RAIN CAP FOR 4.8 CU. METER/MINUTE FILTER
F3-6L 913/914 / D914 L3,4	027-0596 SPL	05051044	PRECLEANER FOR 4.8 CU. METER/MIN. FILTER
F6L914 / D914 L5, L6	027-0597 SPL	05002692 05003526	PRECLEANER FOR 5.6 CU. METER/MIN. FILTER

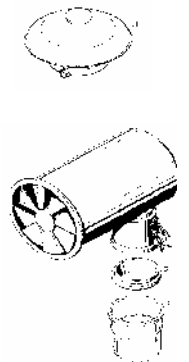

SECT. 3.1

PRECLEANERS, RAIN CAPS

ENGINE MODEL	KIT # / CODE	ETL PAGE	REMARKS
ALL 1013/E / 2012 / 2013	029-2221 SPL	05072246	RAIN CAP FOR 12ccm DRY AIR CLEANERS
ALL 1013/E / 2012 / 2013	029-2222 SPL	05023333	RAIN CAP FOR 15ccm DRY AIR CLEANERS
ALL 2011	2200-0441 SPL	05069129	RAIN CAP FOR OIL BATH AIR CLEANER
ALL 2011	2200-0443 SPL	05051799	PRECLEANER FOR OIL BATH AIR CLEANER
ALL 2011	2200-0798	05069131	RAIN CAP FOR DRY AIR CLEANER

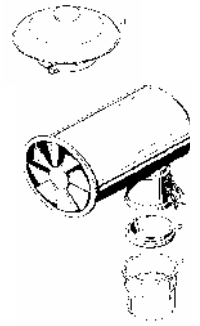

SECT. 3.2

SERVICE INDICATORS, FOR DRY AIR CLEANERS

ENGINE MODEL	KIT # / CODE	ETL PAGE	REMARKS
F3-4L 913/914 / ALL D/TCD914	027-0626 SPL	05075409	MECHANICAL, 50 MBAR
ALL 1013/E / 2012 / 2013	029-0652 SPL	05076508 05069132	MECHANICAL, 50 MBAR
ALL 2011	2200-0429	05075409	MECHANICAL, 50 MBAR
ALL 2011	2200-0568 SPL	05079307	MECHANICAL 35 BAR
ALL 2008 / 2009	3101-0578 SPL	05112210	ELECTRONIC 25 M BAR

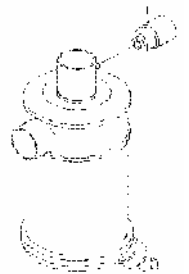

SECT. 3.3

HOSE CONNECTIONS, REMOTE MOUNT AIR CLEANERS

ENGINE MODEL	KIT # / CODE	ETL PAGE	REMARKS
B/F6L 913/C	027-0710	05003536	250 MM LONG, 80 MM I.D.

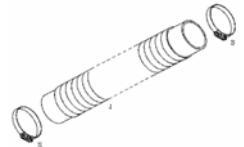

SECT. 3.4

MOUNTING KITS, FOR OIL BATH AIR CLEANERS

ENGINE MODEL	KIT # / CODE	ETL PAGE	REMARKS
BF4L 913	999-0124		FOR FRONT MOUNTING
F5/6L 913	999-0381 SPL		MOUNTING KIT

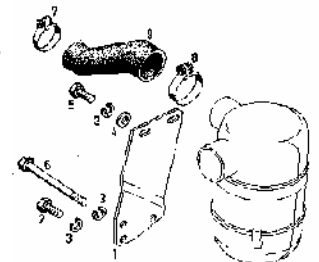

SECT. 4.1 AIR COMPRESSOR, 110 CCM / REV

ENGINE MODEL	KIT # / CODE	ETL PAGE	REMARKS
ALL 1013/E	029-1892	05071844 05111297 05111099	GEAR DRIVEN @ PTO LOCATION "A" AIR COOLED MUST ORDER RELATIVE SUCTION PIPE

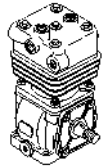

SECT. 4.2 AIR COMPRESSOR, 150 CCM / REV

ENGINE MODEL	KIT # / CODE	ETL PAGE	REMARKS
F3-6L 913	027-1474 SPL	05003877 05032754 05005831	KNORR, FOR ENGINES WITH SINGLE BELT BLOWER DRIVE & W/OUT MOUNTED AIR CLEANER 05005834, 05004701, 05005857, 05006890, 05032744, 05042709
BF6L 913/C	027-2386	05006577 05003877	KNORR 05005834, 05005831, 05006582, 05042027, 05029184 05032744
BF4L 913	027-3725 SPL	05003877 05005834	KNORR 05029159, 05032741, 05003635, 05016307, 05063815
CONTACT DEUTZ (FOR TIER I & TIER II) 914 AIR COMPRESSOR APPLICATIONS			
D914 L3 (TIER III)	027-8641 SPL	05003877 05005834	FOR ENGINES WITHOUT V-BELT GUARD 05006890, 05032744, 05042709, 05005846, 05113380
D914 L4 (TIER III)	027-8642 SPL	05003877 05005831	FOR ENGINES WITHOUT V-BELT GUARD 05005834, 05004701, 05005857, 05006890, 05032744, 05042709, 05113380
D914 L5 (TIER III)	027-7516 SPL	05003877	FOR ENGINES WITHOUT V-BELT GUARD 05005834, 05042027, 05032744, 05003635, 05016307, 05005846
D914 L6 (TIER III)	027-7223 SPL	05003877 05005834	FOR ENGINES WITHOUT V-BELT GUARD 05005831, 05042027, 05032744, 05004701, 05005857, 05003635, 05016307
TCD914 L6 (TIER III)	027-2386	05006577 05003877	FOR ENGINES WITHOUT V-BELT GUARD 05005834, 05005831, 05006582, 05042027, 05032744
F2-4 L/M 2011 / BF4L/M2011	999-0606		FOR ENGINES W/OUT FRONT MOUNTED AIR CLEANER 1. KIT INCLUDES COMPR. MTG. PLATE, LUBE OIL LINE & PULLEYS (AIR COMPRESSOR PULLEY & PTO PULLEY) 2. MUST ORDER TIMING BELT COVER KIT (22003439) 3. FOR ENGINES W/OUT AUXILLARY DRIVE, YOU MUST ORDER AUX. DRIVE BRACKET KIT (22003053) 4. SEE SECT. 6.1 FOR REQUIRED SUCTION PIPE KIT
BF4M1013 /C/E	029-0951 SPL	05070199 05071419	GEAR DRIVE, PTO A, WATER COOLED 05111290, 05111099
BF4M 2012/C	029-5086 SPL	05070199 05070200	PTO "A" WATER COOLED 05072971, 05111287, 05077957
BF6M 2012/C	029-5088 SPL	05070199 05070200	PTO "A" WATER COOLED 05072971, 05111287, 05077782

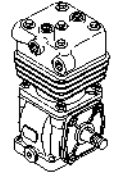

SECT. 4.2.1 AIR COMPRESSOR, 225 CCM

ENGINE MODEL	KIT # / CODE	ETL PAGE	REMARKS
TCD 2012 L4 2V	028-2802 SPL	05111654 05072971	REQUIRES 028-2523 FITTING KIT 05113585, 05111045, 05114099
TCD 2012 L6 2V	028-1837 SPL	05072971 05111654	REQUIRES 028-2523 FITTING KIT 05114688, 05111045, 05111659
TCD 2013 L6 2V	028-1859 SPL	05111654 05111507	REQUIRES 028-2523 FITTING KIT 05114688, 05111191, 05113751
TCD 2013 L6 4V	034-2086 SPL	05115184	,05113715,05110147,05110216,05110239



SECT. 4.3 AIR COMPRESSOR, 300 CCM / REV

F4-6L 913	027-0538	05003877 05032754 05005831	KNORR, FOR ENGINES WITH SINGLE BELT BLOWER DRIVE, INCLUDES SUCTION PIPE TO AIR CLEANER 05004701, 05005857, 05005838, 05005839, 05005840, 05029185, 05037687
BF6L 913/C	027-2394	05003877 05005831 05042027	KNORR NOT AVAILABLE FOR 913C WITH FRONT OR CENTER MOUNT TURBO. 05006581, 05005840, 05029185, 05037687, 05042125
BF4M1013E	029-0955 SPL	05070199 05072477 05113940	GEAR DRIVE, PTO "A" WATER COOLED ALSO REQUIRES 29-2964 BANJO BOLT KIT 05111099
BF6M1013E	029-0959 SPL	05070199 05072070 05071414	GEAR DRIVE, PTO "A" WATER COOLED ALSO REQUIRES 29-2964 BANJO BOLT KIT 05113940, 05111099
BF4M1013/C	29-0953	05070199 05072163 05113940	GEAR DRIVE, PTO "A" WATER COOLED ALSO REQUIRES 29-2964 BANJO BOLT KIT 05111099
BF6M1013/C	29-0957	05070199 05072071 05071414 05113940	GEAR DRIVE, PTO "A" WATER COOLED (INCLUDES COOLING WATER LINES) ALSO REQUIRES 29-2964 BANJO BOLT KIT 05111099
BF6M1015 /C	2201-0578 SPL	05068405 05068406	GEAR DRIVE, PTO "A" WATER COOLED 05067885, 05068407, 05068408, 05068409, 05078567 05067911
BF6M1015 /C	2201-0588 SPL	05068405 05067897	GEAR DRIVE, PTO "B" WATER COOLED 05067885, 05069358, 05067975, 05067887, 05078567 05067911
BF8M1015 /C	2201-0580 SPL	05068405 05067885	GEAR DRIVE, PTO "A" WATER COOLED 05068413, 05069284, 05068415, 05068416, 05067911 05078563
BF8M1015 /C	2201-0590 SPL	05068405 05067885	GEAR DRIVE, PTO "B" WATER COOLED 05069285, 05077482, 05068420, 05067911, 05078563 05068413
BF6M 2012C	029-5082 SPL	05070199 05070200	PTO "A" WATER COOLED 05072971, 05077758, 05113936
BF4M 2012/C	029-5090 SPL	05070199 05070200	PTO "A" WATER COOLED 05072971, 05113936, 05077976
TCD 2015 V6/4V	2203-0287 SPL	05068405 05067885 05068408	PTO "A" W/OUT STEERING PUMP (REQUIRES "A" DRIVE GEAR SEE SEC #20.2 05079793, 05076797, 05075567, 05075563, 05078567

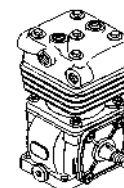

CONTINUED ON NEXT PAGE

CHECK WITH DC-NORCROSS FOR LEAD TIME ON ITEMS WITH 'SPL' STOCK CODE

SECT. 4.3 AIR COMPRESSOR, 300 CCM / REV

ENGINE MODEL	KIT # / CODE	ETL PAGE	REMARKS
TCD 2015 V6/4V	22030294 SPL	05068405 05067885 05067975	PTO "B" W/OUT STEERING PUMP (REQUIRES "B" DRIVE GEAR SEE SEC #20.2 05079793, 05076798, 05075566, 05075564
TCD 2015 V8/4V	2203-0235 SPL	05068405 05067885 05068408	PTO "A" W/OUT STEERING PUMP (REQUIRES "A" DRIVE GEAR SEE SEC #20.2 05079793, 05076798, 05075566, 05075563, 05078567
TCD 2015 V8/4V	22030295 SPL	05068405 05067885 05067975	PTO "B" W/OUT STEERING PUMP (REQUIRES "B" DRIVE GEAR SEE SEC #20.2 05079793, 05076798, 05075566, 05075564

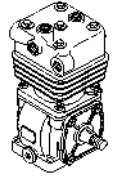

SECT. 4.4 AIR COMPRESSOR, 360 CCM / REV

ENGINE MODEL	KIT # / CODE	ETL PAGE	REMARKS
TCD 2012 L6	028-1836 SPL	05111654 05072971	REQUIRES 28-2523 FITTING KIT 05113587, 05111503, 05111660, 05111657
TCD 2013 L6	028-1860 SPL	05111654 05111507	REQUIRES 28-1914 FITTING KIT 05110765, 05113717, 05113721, 05111658

SECT. 5.2 AIR COMPRESSOR, 600 CCM / REV

ENGINE MODEL	KIT # / CODE	ETL PAGE	REMARKS
BF6M1013E/EC/ECP	029-3553 SPL	05071882 05071883 05071413	GEAR DRIVE, PTO "A" WATER COOLED ALSO REQUIRES BANJO BOLT KIT (#29-2964) 05071875, 05072971, 05111291
BF6M1013/C/CP	029-3552 SPL	05071882 05071883 05071874	GEAR DRIVE, PTO "A" WATER COOLED ALSO REQUIRES BANJO BOLT KIT (#29-2964) 05071875, 05072971, 05111291
BF8M1015/C	2201-1339 SPL	05068413 05067911	GEAR DRIVE, PTO "A" WATER COOLED 05076872, 05069234, 05069425, 05069426, 05069427
TCD 2015	2203-0234	05076872	05069234,05079793,05075562,05075565,05075694,05075695

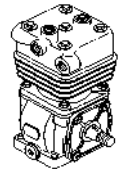

SECT. 5.4 FITTINGS, FOR AIR COMPRESSORS AND REGULATORS

ENGINE MODEL	KIT # / CODE	ETL PAGE	REMARKS
ALL	027-0568	05002236 05003559	PRESSURE REGULATOR
1013 / 2012	999-0391		INLET / OULET FITTING KIT FOR AIR COMPRESSOR (FOR 300-600 CCM)
BF4/6M2012/C	029-5147 SPL	05078684	FOR WATER COOLED COMPRESSORS
MISC. SEE REMARKS	999-0181	05078248	SAE 37 DEGREE FLARE SCREW FITTINGS. FOR USE WITH AIR REGULATORS SUPPLIED WITHOUT METRIC FITTINGS.
MISC. SEE REMARKS	999-0182		SAE 37 DEDREE FLARE SCREW FITTINGS, FOR USE WITH AIR COMPRESSORS SUPPLIED WITHOUT METRIC FITTINGS.
TCD2012 L4 / L6	028-2523 SPL	05078684	FITTING KIT FOR 225/360 CCM AIR COMP
TCD 2013 L6	028-1914 SPL	05072099	FITTING KIT FOR 360 CCM AIR COMP



SECT. 6.1 SUCTION PIPE KITS FOR AIR COMPRESSORS

ENGINE MODEL	KIT # / CODE	ETL PAGE	REMARKS
BF4M 1013/C/E	029-3380 SPL	05072387	FOR USE WITH 300ccm GEAR DRIVEN AIR COMP (ENGINE WITH REAR TURBO)
F2-4L/M2011	999-0634 SPL		FOR USE WITH 9990606 (150CCM AIR COMPRESSOR)
BF4L/M2011	999-0608 SPL		FOR USE WITH 9990606 (150CCM AIR COMPRESSOR)
BF6M1013/C/CP/E/EC/ECP	029-0961 SPL	05072387	FOR USE WITH 300ccm GEAR DRIVEN AIR COMP (ENGINE WITH REAR TURBO)

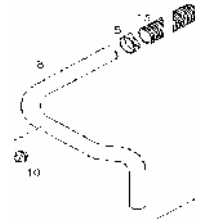

SECT. 7.1 COOLING AIR DISCHARGE DUCTING

ENGINE MODEL	KIT # / CODE	ETL PAGE	REMARKS
F4L913/914	027-3121 SPL	05027662 05004627	DISCHARGE DUCTING UPWARDS.
D914 L4	027-8658	05003591 05078533	DISCHARGE FROM HYD OIL COOLER & EXHAUST SIDE
BF6L914C	027-7519 SPL	05031778 05079931	DISCHARGE FROM HYD OIL COOLER & EXHAUST SIDE 05113325
BF4L914	027-3602 SPL	05042828 05042830	DISCHARGE DUCT SIDEWAYS W/OUT CAC OR HOC 05042831
BF6L914C / TCD914 L6	027-7491 SPL	05079931 05113325	DISCHARGE FROM EXHAUST SIDE
F2L2011 / D2011 L2 I	2200-2051 SPL	05069015	DISCHARGE TOP FROM LUBE OIL COOLER
F2L2011 / D2011 L2 I	2200-2052 SPL	05051712 05069015	DISCHARGE FROM LUBE OIL COOLER AND CYLINDER HEADS TO THE SIDE
F3L2011 / D2011 L3 I	2200-2053	05068257	DISCHARGE TOP FROM LUBE OIL COOLER
F3L2011 / D2011 L3 I	2200-2054 SPL	05051714 05068257	DISCHARGE FROM LUBE OIL COOLER AND CYLINDER HEADS TO THE SIDE
F4L2011	2200-2055	05069012	DISCHARGE TOP FROM LUBE OIL COOLER ONLY
F4L2011	2200-2056 SPL	05051716 05069012 05114872	DISCHARGE TOP FROM LUBE OIL COOLER TO SIDE (WITH SIDE OUTLET EXH. MANIFOLD ONLY)
BF4L2011	2200-3251 SPL	05069040 05074379 05114872	DISCHARGE TOP FROM LUBE OIL COOLER TO SIDE (WITH SIDE OUTLET EXH. MANIFOLD ONLY)
BF4L2011	2200-3250 SPL	05074379	DISCHARGE TOP COVER ONLY
D2011 L4 I	2200-4943 SPL	05114980	DISCHARGE TOP FROM LUBE OIL COOLER
TD2011 L4 I	2200-4530 SPL	05119024 05119005	DISCHARGE TOP FROM LUBE OIL COOLER TO SIDE (WITH SIDE OUTLET EXH. MANIFOLD ONLY)

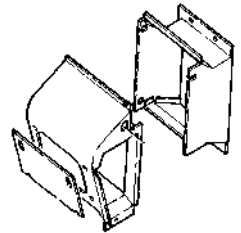

SECT.7.2

AIR INTAKE GUIDE RING FOR COOLING BLOWER

ENGINE MODEL	KIT # / CODE	ETL PAGE	REMARKS
BF4L 913 , F5-6L914 D914 L5,6	027-0682	05030263	AIR FEED RING
BF6L 913/C/TCD914 L6	027-2399	05037611	AIR FEED RING
F3-4L 913/914 / D914 L3,4	027-2401	05027654	AIR FEED RING
BF4M1013	029-1384 SPL	05072273	FOR USE WITH 300 MM BLOWER ONLY
ALL 1013	029-1385 SPL	05072152	FOR USE WITH 370 MM BLOWER ONLY
BF4M1013	029-2251 SPL	05071934 05072273	FOR USE WITH 300 MM BLOWER ONLY HAS SEALING LIP
BF4-6M1013	029-2252 SPL	05071935 05072152	FOR USE WITH 370 MM BLOWER ONLY HAS SEALING LIP
ALL B/FL2011 D2011 L2 I / L3 I D,TD2011 L4 I	2200-1602	05067679 05067681	GUIDE RING WITH GRILLE GUARD AND SEAL (PLASTIC ONE PIECE)

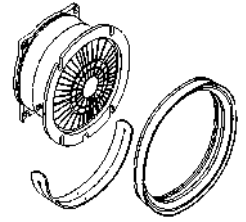

SECT.8.1 ALTERNATOR, BOSCH 12 VOLT 55AMP

ENGINE MODEL	KIT # / CODE	ETL PAGE	REMARKS
F4-6L913 F5L914 BF4L914 / D914 L5	027-4923 SPL	05016366 05023307	FOR 1 OR 2 BELT BLOWER 05079557, 05079570, 05079578, 05113253
F3/F4L914 / D914 L3,4	027-4419 SPL	05032660 05063653	FOR SINGLE BELT BLOWER 05079557, 05079569, 05113253
F3/F4L914 / D914 L3,4	027-4936 SPL	05032362 05034245	FOR 2 BELT BLOWER 05079557, 05079558, 05079578, 05113253
F4-6L913 F6L914 / D914 L6	027-4927 SPL	05016366 05022857	FOR 1 OR 2 BELT BLOWER 05079557, 05079569, 05113253
BF6L 913/914/C / TCD914 L6	027-4926 SPL	05016366 05023029	FOR GENERATOR 05079557, 05079569, 05113253
F3-4L 913	027-4944 SPL	05034244 05032362	FOR GENERATOR 05079557, 05079558, 05079578, 05113253
BF4-6M1013C	029-2107 SPL	05070117 05079569	FOR DRIVE B 05078504, 05079557

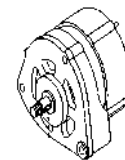

SECT.8.2 ALTERNATOR, BOSCH 12 VOLT 95AMP

ENGINE MODEL	KIT # / CODE	ETL PAGE	REMARKS
BF6L 913/C/914	027-4949 SPL	05016366 05079569	KIT, 05005976, 05023029, 05064817, 05064986 05079608, 05079578
F5L914/ BF4L913/914 D914 L5	027-4951 SPL	05016366 05079608	KIT, 05023307, 05064817, 05064986, 05079570 05079578
F6L 913/914	027-4960 SPL	05016366 05079570	KIT, 05022857, 05064817, 05064986, 05003639 05079608, 05079578
F3-4L913 / D913 L4	027-5308 SPL	05034244 05079608	KIT, 05032362, 05064817, 05064986, 05079558 05079578
BF4M2012/BF4M/6M2012C	029-4732 SPL	05074923	KIT, 05077778, 05113874
TCD 2012 L4/L6	028-1789 SPL	*	SAME AS 029-4732
TCD 2013 L4/L6	028-1939 SPL	05111388 05077778	POLY V 05113874
ALL 1013	029-2617 SPL	05071771	05076245, 05079608, 05079558, 05078506

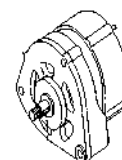

SECT.8.2.1 ALTERNATOR, BOSCH 12 VOLT 150AMP

ENGINE MODEL	KIT # / CODE	ETL PAGE	REMARKS
TCD914 L06	027-7125 SPL	05075013	05075029, 05075363, 05111580
BF4M2012 /BF4 / 6M2012C	029-4733 SPL	05074923	KIT, 05111580, 05113874
TCD2012 L4/L6	028-1790 SPL		SAME AS 029-4733
TCD2013 L4/L6 2V	028-1941 SPL	05111388 05111580	POLY V 05113874

CONTINUED ON NEXT PAGE

SECT.8.3 ALTERNATOR, BOSCH 24 VOLT 35AMP

ENGINE MODEL	KIT # / CODE	ETL PAGE	REMARKS
BF4L 913 / D914 L5	027-4541	05023307 05113253	KIT, 05016366, 05079570, 05079578, 05079568
F6L914 / D914 L6	027-4542 SPL	05016366	KIT, 05022857, 05079570, 05079568, 05113253
BF6L 913/C / TCD914 L6	027-4543 SPL	05016366	KIT, 05023029, 05079569, 05079568, 05113253
F3-4L 913 /914 / D914 L3,4	027-4546 SPL	05034244 05113253	KIT, 05032362, 05079558, 05079578, 05079568
BF4-6M1013C	029-2111 SPL	05070117 05079569	FOR DRIVE B 05078504, 05079568

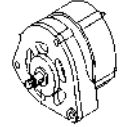

SECT.9.1 ALTERNATOR, BOSCH 24 VOLT 55AMP

ENGINE MODEL	KIT # / CODE	ETL PAGE	REMARKS
F3/F4L914 / D914 L3,4	027-2422 SPL	05016366	05113028, 05079911, 05079578, 05079912
F5/F6L914 BF4L914 D914 L5,6	027-5471 SPL	05016365	05079911, 05079578, 05079912, 05063712, 05113388
TCD914 L6	027-2421 SPL	05079912	05113388, 05079578, 05113495, 05063762
BF4-6M1013C	029-2113 SPL	05070169 05030812 05079912	FOR DRIVE B 05071230, 05072174, 05070117, 05111037, 05079911
BF4-6M1013/E/C/P	029-2618 SPL	05071771 05076245	BLOWER DRIVE D 05079558, 05078506, 05079568
ALL 2012	029-4735 SPL	05074923 05077776	FOR POLY-V FAN DRIVE 05113874
TCD2012 L4/L6	028-1791 SPL	*	SAME AS 029-4735
TCD2013 L4/L6	028-1942 SPL	05111388 05077776	POLY V 05113874

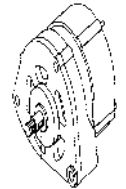

SECT.9.1A ALTERNATOR, BOSCH 24 VOLT 80AMP

ENGINE MODEL	KIT # / CODE	ETL PAGE	REMARKS
1013/C	029-3138 SPL	05070169 05070117 05078490	24V 80AMP V-BELT DRIVE "B" VIA LIQUID PUMP 05022986, 05078025, 05078167, 05076643 05113167
1013E	029-3139 SPL	05070169 05071449	24V 80AMP V-BELT DRIVE "B" VIA LIQUID PUMP 05022986, 05078025, 05079558, 05076643, 05111042
1015	2201-9137 SPL	05067871	24V 80 AMP - ETL 05076764
ALL 2012	029-4736 SPL	05074923 05076643	FOR POLY-V FAN DRIVE 05113874
TCD 2012 L4/L6	028-1792 SPL		SAME AS 029-4736
TCD 2013 L4/L6	028-1943 SPL	05111388 05076643	POLY V 05113874
ALL 2013	028-1949 SPL	05076643 05078378	05113167 05078490

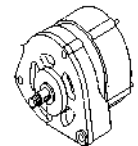

SECT. 9.2 ALTERNATOR, FOR 2011 ENGINES

ENGINE MODEL	KIT # / CODE	ETL PAGE	REMARKS
F2/3L2011 / D/TD 2011 L I	2200-3087 SPL	05079007 05079235	12 VOLT, 80 AMP 05051119, 05063447
F/BFL2011 / D/TD 2011 L I	2200-3089 SPL	05069052 05079008	24 VOLT, 40 AMP 05079235, 05051119, 05063447
ALL FM 2011 / D 2011 L2,L3	2200-1595 SPL	05063447 05068114	12 VOLT 55 AMP, W/O HIGH MOUNT FAN DRIVE 05079132
ALL FM 2011 / D 2011 L2,L3	2200-1596 SPL	05063447 05068114	12 VOLT 95 AMP, W/O HIGH MOUNT FAN DRIVE 05079131
ALL FM 2011 / D 2011 L2,L3 ALL 2011 W	2200-1598 SPL	05074365 05079132	12 VOLT 55 AMP, W/ HIGH MOUNT FAN DRIVE
ALL FM 2011 / D 2011 L2,L3 ALL 2011 W	2200-4619 SPL	05079131	12 VOLT 95 AMP (ALTERNATOR ONLY)
ALL FM 2011 / D 2011 L2,L3 ALL 2011 W	2200-4620 SPL	05079138	24 VOLT 35 AMP (ALTERNATOR ONLY)

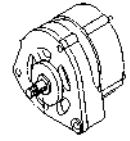

SECT. 9.3 ALTERNATOR FOR 2008 / 2009 ENGINES

ENGINE MODEL	KIT # / CODE	ETL PAGE	REMARKS
TD2009L4	3101-0580 SPL	05112026	12 VOLT 50 AMP (FOR 122MM CRANK PULLEY)
D2009L4	3101-0338 SPL	05112025	12 VOLT 50 AMP (FOR 104MM CRANK PULLEY)
D2009L3	3101-0339 SPL	05112183	12 VOLT 50 AMP (FOR 104MM CRANK PULLEY)

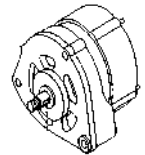

SECT. 10.2 BLOWER GUARDS

ENGINE MODEL	KIT # / CODE	ETL PAGE	REMARKS
BF4-6M1013	029-2000 SPL	05070161	FOR 300 MM BLOWER AND TRIANGLE DRIVE A
BF4-6M1013	029-2001 SPL	05070426	FOR 370 MM BLOWER AND TRIANGLE DRIVE A
ALL 2011	2200-1599	05068069	BLOWER GUARD, PLASTIC ONE PIECE

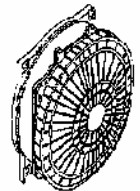

SECT. 11.0 C-6 ADAPTER

ENGINE MODEL	KIT # / CODE	REMARKS
2011	999-0230 SPL	FOR C6 FORD TRANS. REQUIRES 8"/10" FLYWHEEL AND #4 INTERMEDIATE HOUSING

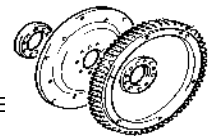

SECT. 11.1 FLYWHEEL, SAE 6.5

ENGINE MODEL	KIT # / CODE	ETL PAGE	REMARKS
ALL 2011	2200-3174	05074222	ALSO FOR CENTAFLEX SIZE 16 (FOR MOD 3 FLYWHEEL)
DL4 / TD2009L4 , D2008L4	3101-0627 SPL		
D2008L3 / D2009L3	3101-0628 SPL		

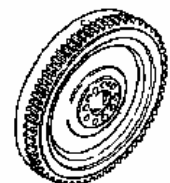

SECT. 11.1.1

FLYWHEEL, SAE 7.5

ENGINE MODEL	KIT # / CODE	ETL PAGE	REMARKS
DL4 / TD2009L4 , D2008L4	3101-0355 SPL	05112005	0.217 KGM
D2009L3 , D2008L3	3101-0356 SPL	05112161	0.217 KGM
DL4 / TD 2009L4 , D2008L4	3101-0629 SPL	05112329	0.302 KGM
D2009L3 , D2008L3	3101-0630 SPL		0.302 KGM

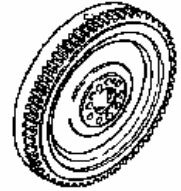

SECT. 11.2

FLYWHEEL, SAE 8/10"

ENGINE MODEL	KIT # / CODE	ETL PAGE	REMARKS
B/F3-6L913/C/914 D914 L3,4,5,6 / TCD914 L6	027-0403 SPL	05006880	ALSO FOR CENTAFLEX
ALL 1013 / 2012 / 2013	029-1408 SPL	05070429	KIT, 05072759, 05074521
ALL 2011	2200-2461	05074151	FOR CENTAPLEX COUPLING SIZE 25 & 30



SECT. 11.3

FLYWHEEL, 9"

ENGINE MODEL	KIT # / CODE	ETL PAGE	REMARKS
ALL 2011	2200-3175 SPL	05074331	ALSO FOR F&S CLUTCH MF228
DL4 / TD2009L4 , D2008L4	3101-0357 SPL		0.207 KGM AUTOMOTIVE
D2009L3 , D2008L3	3101-0358 SPL	05112311	0.207 KGM AUTOMOTIVE

SECT. 11.4

FLYWHEEL, SAE 10/11.5"

ENGINE MODEL	KIT # / CODE	ETL PAGE	REMARKS
ALL 1013/E	029-0605 SPL	05070859 05072759 05074521	SAE 10/11.5 FOR GEN. SET @1500/1800 RPM HEAVY ALSO FOR CENTAFLEX SIZE A 30, 50 AND 90s
TCD2012/2013	028-1630 SPL	05072759 05074521 05070859	SAE 10/11.5 FOR GEN. SET @1500/1800 RPM HEAVY ALSO FOR CENTAFLEX SIZE A 30, 50 AND 90s
ALL 1013/E / 2012	029-1406 SPL	05070346 05070383	SAE 10/11.5 STANDARD 05072759
TCD2012/2013	028-1634 SPL	05072759 05070346	SAE 10/11.5 STANDARD 05070383
DL4 / TD2009L4	3101-0514 SPL	05112253	SAE 10" WITH BEARING CARRIER
DL4 / TD 2009L4	3101-0512 SPL	05112253	SAE 10" W/OUT BEARING CARRIER



SECT. 12.2

FLYWHEEL, SAE 14 "

ENGINE MODEL	KIT # / CODE	ETL PAGE	REMARKS
BF6M1013/E/C/P	029-0738 SPL	05070580	KIT, 05070660, 05110891
TCD 2013	028-1632 SPL	05070580	KIT, 05070660, 05110891
1015	2201-0651 SPL	05076718	KIT



SECT. 12.3

FLYWHEEL, ALLISON APPLICATIONS

ENGINE MODEL	KIT # / CODE	ETL PAGE	REMARKS
B/F3-6L913/C/914	027-0433 SPL	05005922	FOR TT 2000
B/F4-6L913/C/914 1013 / 2012	999-0235 SPL 999-0245 SPL		FLYWHEEL AT540/545 (ENGINE MUST HAVE SAE 3 HSG.) (SAME AS 28-1647) FLEX PLATE ONLY (IF ENGINE COMES WITH 29-3190 FLYWHEEL)
1015	2201-1470 SPL	05075983 05021577	W/ OUT RING GEAR
TCD2015 V6/V8	2203-0480 SPL	05079746	SAE 1 (ALLISON CLTB755)

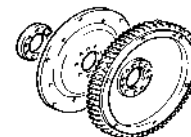

SECT. 12.4

FLYWHEEL, BORG WARNER APPLICATIONS

ENGINE MODEL	KIT # / CODE	ETL PAGE	REMARKS
B/F3-6L 913/C/914 / D914 L3	027-2637	05063705 05070429	FOR 11 T.C.
ALL 1013/E / 2012 TCD 2012/2013	029-1642 SPL	05070580 05071907	FOR BORG WARNER 11 " TC 05071846, 05072759
ALL 2011	2200-2462	05074287	FOR SSL 11



SECT. 13.1

FLYWHEEL, CLARK APPLICATIONS

ENGINE MODEL	KIT # / CODE	ETL PAGE	REMARKS
B/F3-6L 913/C/914 D914 L4,5,6 / TCD914 L6	027-0407	05022874	FOR C2000/HR18000
B/F3-6L 913/C / D914 L6 TCD914 L6	027-0430	05003384	FOR C271/HR28000
ALL 1013/2012/2013	029-6085 SPL	05071010 05072759	FOR HR 18000 & HR 28000 (SAME AS 28-1633) 05074521, 05076174
BF6M1013/E/C/P	029-2715 SPL	05070580 05071864	FOR C5000, HR34000, HR36000 / USE ONLY WITH SAE 1 HOUSING 05071865



SECT. 13.2

FLYWHEEL, FLAT FACE

ENGINE MODEL	KIT # / CODE	ETL PAGE	REMARKS
B/F3-6L 913/C/914 / D914 L3	027-0431	05006884	WITHOUT BEARING RETAINER
2011	2200-3186	05074319	ROCKFORD 11 RT CLUTCH
BF6L 913 / C-F6L / BF6L914C D914 L6 / TCD 914 L6	027-7195 SPL	05071834 05074521	F + S / CLUTCH 380 05076239



SECT. 13.3 ENGINE MODEL	FLYWHEEL HOUSING, SAE 1 KIT # / CODE	ETL PAGE	REMARKS
ALL 1013E/FC	029-2351 SPL	05070659 05074550	W/TORQUE CONVERTER MTG. PLATE (143MM) 05078272, 05078462
TCD 2013	028-1601 SPL	05078272 05078462	W/TORQUE CONVERTER MTG. PLATE (143MM) 05070659, 05074550
ALL 1013E	029-0636 SPL	05070659 05078272	W/OUT TORQUE CONVERTER MTG. PLATE (143MM DEEP) 05078462, 05078481
TCD 2013	028-1600 SPL	05078272 05078462	W/OUT TORQUE CONVERTER MTG. PLATE (143MM DEEP) 05070659, 05078481 (SAME AS 28-2824)
ALL 1013C	029-0637 SPL	05070659	KIT, 05078272, 05078487
ALL 1015	2201-1465 SPL	05068558 05069756	OIL & WATER TIGHT 05075985, 05075582
TCD2015 V6/V8	2203-0323 SPL	05076696	05079745, 05075623

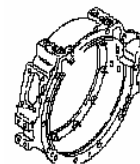

SECT. 13.4 ENGINE MODEL	FLYWHEEL HOUSING, SAE 2 KIT # / CODE	ETL PAGE	REMARKS
B/F3-6L 913/C/ ALL 914	027-0749	05006908	KIT
ALL 1013E	029-0629 SPL	05070654	122MM DEEP, 05078272, 05078462
TCD 2013	028-1603 SPL	05078272	122MM DEEP, 05078462, 05070654
ALL 1013C	029-0630 SPL	05070654	KIT, 05078272, 05078485
BFM 2012/C	029-1396 SPL	05070031	122MM DEEP, 05078272, 05078462
TCD 2012	028-1623 SPL	05078272	122MM DEEP, 05070031, 05078462

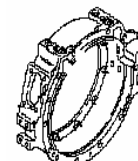

SECT. 14.1 ENGINE MODEL	FLYWHEEL HOUSING, SAE 3 KIT # / CODE	ETL PAGE	REMARKS
B/F3-6L 913/C/ ALL 914	027-0748 SPL	05006906	KIT
ALL 1013E	029-0631 SPL	05070482	KIT, 05078272, 05114149
TCD2013	028-1523 SPL	05114149	KIT, 05070482, 05078272
ALL 1013C	029-0638 SPL	05070482	KIT, 05078272, 05078461
2012/C	029-1398 SPL	05070032	KIT, 05078272, 05114149
TCD 2012	028-1624 SPL	05078272	KIT, 05070032, 05114149
ALL 2011	2200-1053	05051756 05063372	ONE PIECE SAE HOUSING

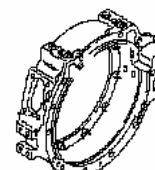

SECT 14.2 ENGINE MODEL	FLYWHEEL HOUSING, SAE 4 KIT # / CODE	ETL PAGE	REMARKS
B/F3-6L 913/C/ ALL 914	027-0747	05003819	KIT

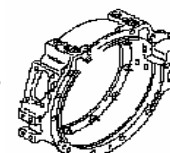

SECT. 14.3 ENGINE MODEL	FLYWHEEL HOUSING, SAE 4 KIT # / CODE	ETL PAGE	REMARKS
ALL 1013C	029-0634 SPL	05070482	05078272, 05078486, 05078462
2012/C	029-1400 SPL	05070032	05078272, 05078462, 05078460
TCD 2013	028-1607 SPL	05078272	05070482, 05078462, 05078460
ALL 2011	2200-0550 SPL	05051756 05069152	INTERMEDIATE HOUSING & ADAPTOR RING 05079261
ALL 2011	2200-0553 SPL	05051756 05069152	INTERMEDIATE HOUSING ONLY
ALL 2011	2200-1054 SPL	05051756 05063423	ONE PIECE SAE HOUSING
ALL 2011	2200-3226	05074055	HOUSING & ADAPTER RING / WITH TACH GENERATOR 05074269,05079261,05051756,05071486
ALL 2008 / 2009	3101-0350 SPL	05112149	98 MM WIDTH
	3101-0347 SPL	05112112	81 MM WIDTH
	3101-0348 SPL	05112221	132 MM WIDTH
DL4 / TD 2009L4	3101-0351 SPL	05112220	161 MM WIDTH

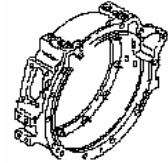

SECT. 14.4 ENGINE MODEL	FLYWHEEL HOUSING, SAE 5 KIT # / CODE	ETL PAGE	REMARKS
B/F3-6L 913/C/914 D914 L3,4 ALL 2011	027-1545 SPL 2200-0551	05004622 05051310 05051756	ENGINE COMPLETION SUPPLIES SA 027-0694 DUST COVER, PRODUCTION ENGINES DO NOT SAE ADAPTOR RING ONLY 05069152
ALL 2011	2200-1332 SPL	05051756 05068210	80 MM HOUSING - MAG PICK UP 05068211
ALL 2011	2200-2235 SPL	05051310 05051339	HOUSING & ADAPTER RING 05051756
All 2008 / 2009	3101-0346 SPL	05112022	98 MM WIDTH
	3101-0349 SPL	05112111	81 MM WIDTH

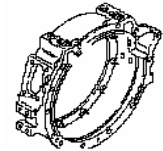

SECT. 15.1 ENGINE MODEL	DUST COVER FOR FLYWHEEL HOUSING KIT # / CODE	ETL PAGE	REMARKS
B/F3-6L 913/C/914	027-0694 SPL	05032425	KIT
ALL 1013/C/E	029-1340 SPL		KIT



SECT. 16.1

FUEL TANKS

ENGINE MODEL	KIT # / CODE	ETL PAGE	REMARKS
F6L 913/914	027-0795 SPL	05003505 05003489	90 LITER, SHEET METAL 05003701
F3L913	027-3275 SPL	05003505 05003489	90 LITER, SHEET METAL 05006847
ALL 2011	2200-0637	05051667	20 LITER, SHEET METAL. NOT WITH MOUNTED CONTROL PANEL ON INTERMEDIATE HOUSING

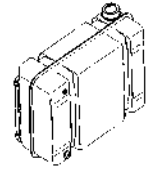

SECT. 16.2

FUEL FILTERS

ENGINE MODEL	KIT # / CODE	ETL PAGE	REMARKS
B/F6L913/C	027-1209 SPL	05030195 05032548	LOOSE, REQUIRED FOR CAB OIL HEAT
BF4L 913	027-2514 SPL	05022935 05032518	LOOSE, REQUIRED FOR CAB OIL HEAT
ALL 1013/E(INT. & EXT.)	029-1253 SPL	05077129 05114080	LOOSE
ALL 1013/E(INT. & EXT.)	029-1463 SPL	05070201	LOOSE, WITH WATER SEPERATOR
ALL 1013/E(INT. & EXT.)	029-2412	05078200	FUEL PRE-FILTER, LOOSE WITHOUT CONNECTIONS OR BRACKET.
1013 / 2012	029-6110 SPL	05078100 05075982	RACOR PRE-FILTER WITH ELEC. WATER LEVEL INDICATOR - INCLUDES PLUG
ALL 2011	2200-1724 SPL	05068026 05067542	.6 LITER, MOUNTED, WITH WATER SEPERATOR MUST MOUNT REMOTELY FOR F2L/M 1011F UP TO 2300 RPM
ALL 2011	2200-1721 SPL	05069150	.4 LTR SPIN ON CARTRIDGE, LOOSE
ALL 2011	2200-1722 SPL	05068026 05042000	.4 LTR. SPIN ON CARTRIDGE, MOUNTED
TCD 2012/2013	028-1878 SPL	05113200 05079675	PRE-FILTER RACOR WITH HAND PRIMER & WATER IN FUEL SENSOR (SAME AS 034-1716)
TCD 2015	2203-0569 SPL	05078576 05079674	PRE-FILTER RACOR WITH HAND PRIMER & WATER IN FUEL SENSOR 05079675



SECT. 16.3

FUEL FITTINGS

ENGINE MODEL	KIT # / CODE	ETL PAGE	REMARKS
ALL 1013/E	029-2354 SPL	05071050	3/8 NPT, 1X FITTING FOR FUEL PUMP
ALL 1013/E	029-2658	05071050	3/8 NPT, 3X FITTINGS FOR FUEL PUMP AND PREFILTER
ALL 1013/E	029-2659 SPL	05071049	10mm SLIP-ON, 3x FITTINGS PUMP & PREFILTER



SECT. 16.4

FUEL PRIMER PUMP

ENGINE MODEL	KIT # / CODE	ETL PAGE	REMARKS
BF6/8M1015/C	2201-0605 SPL	05068668	KIT
BF6M 1013/CP/2012	029-3490 SPL	05078373	WITHOUT FUEL PRE-FILTER



SECT. 17.1 HYDRAULIC OIL COOLER, CLASS I

ENGINE MODEL	KIT # / CODE	ETL PAGE	REMARKS
F6L 913/914	027-1109 SPL	05022945 05003579	SAE 2,3,4 HOUSING, SINGLE-BELT BLOWER DRIVE, EQUIP. M 05032464, 05034232
F6L 913/914	027-1110 SPL	05022945 05003579	SAE 2,3,4 HOUSING, DOUBLE-BELT BLOWER DRIVE, EQUIP. M 05034232, 05071965
BF6L 913/914	027-2195 SPL	05006548 05006549	DOUBLE-BELT BLOWER DRIVE, EQUIP. K 05042706, 05070779
F4L 913	027-2638	05030989 05003579	SINGLE-BELT BLOWER DRIVE, EQUIP. R 05030216, 05032492
F3L 913	027-2855 SPL	05030989 05004510	SINGLE-BELT BLOWER DRIVE, EQUIP. R 05030217, 05042705
F4L 913	027-2872 SPL	05003579 05030988	DOUBLE-BELT BLOWER DRIVE, EQUIP P 05030216, 05032492
BF4L 913	027-3836	05034232 05032463 05042838	SAE 2,3, HOUSING, SINGLE-BELT BLOWER DRIVE, EQUIP. N 05042827

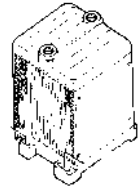

SECT. 17.2 HYDRAULIC OIL COOLER, CLASS II

ENGINE MODEL	KIT # / CODE	ETL PAGE	REMARKS
F6L 913/914/ D914 L6	027-1119	05032463 05027671 05032514	SAE 2,3 HOUSING, SINGLE-BELT BLOWER DRIVE, EQUIP D 05034387
F6L 913	027-1120 SPL	05032463 05027671 05032516	SAE 4 HOUSING, DOUBLE-BELT BLOWER DRIVE, EQUIP D 05034387
F4L 914 / D914 L4	027-2884 SPL	05030988 05027671 05023370	SAE 2,3 HOUSING, DOUBLE-BELT BLOWER DRIVE, EQUIP F 05027670

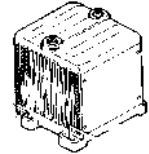

SECT. 17.3 HYDRAULIC OIL COOLER, CLASS III

ENGINE MODEL	KIT # / CODE	ETL PAGE	REMARKS
BF4L 913/914	027-3608 SPL	05042281 05042270	SAE 2,3 HOUSING U TYPE 05032463, 05042827
BF6L 913/914	027-2205 SPL	05030829 05030830 05042706	SAE 2,3 HOUSING, DOUBLE-BELT BLOWER DRIVE, EQUIP C 05070779

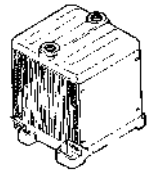

SECT. 18.2 HYDRAULIC OIL COOLER, SIZE C

ENGINE MODEL	KIT # / CODE	ETL PAGE	REMARKS
BF6M1013	029-2097 SPL	05070609 05070512 05070920 05071466 05111015	INCLUDES IMPELLER FOR BLOWER, MUST ORDER DRIVE PARTS FOR BLOWER 05070344, 05070923, 05070918, 05070607, 05070513 05072331, 05072338, 05072332, 05072348, 05077230 05111016

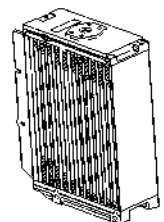

SECT. 18.3 ENGINE OIL COOLER FOR CRANKSHAFT DRIVEN FAN

ENGINE MODEL	KIT # / CODE	REMARKS
F3/4M 2011	999-0231 SPL	ENGINE OIL COOLER (FOR 290MM FAN)
BF3/4M 2011	999-0244	ENGINE OIL COOLER (FOR 315 MM FAN)
	999-0332 SPL	HOSE KIT

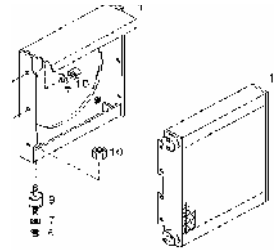

SECT. 18.4 FANS FOR 2011 HYDRAULIC OIL AND FM 2011 ENGINE LUBE OIL COOLERS

ENGINE MODEL	KIT # / CODE	ETL PAGE	REMARKS
ALL 2011	2200-0898 SPL	05051746	FOR FRONT PTO CRANKSHAFT MOUNT 270 MM DIAMETER FAN ONLY. DRIVE HUB IS ALSO REQUIRED, SEE SECTION 36.2
ALL 2011	2200-0899	05051747	FOR FRONT PTO CRANKSHAFT MOUNT 315 MM DIAMETER FAN ONLY. DRIVE HUB IS ALSO REQUIRED, SEE SECTION 36.2
ALL 2011	2200-0900 SPL	05051748	FOR FRONT PTO CRANKSHAFT MOUNT 330 MM DIAMETER FAN ONLY. DRIVE HUB IS ALSO REQUIRED, SEE SECTION 36.2
ALL 2011	2200-0933 SPL	05051745	FOR FRONT PTO CRANKSHAFT MOUNT 290 MM DIAMETER FAN ONLY. DRIVE HUB IS ALSO REQUIRED, SEE SECTION 36.2



SECT. 18.5 AG ENGINE OIL COOLERS

ENGINE MODEL	KIT # / CODE	ETL PAGE	REMARKS
F3L2011	2200-1541 SPL	05067763	
F4L2011	2200-1542 SPL	05068045	
D2011 L4i	2200-4676	05114784	
TD2011 L4i	2200-4985	05119022	

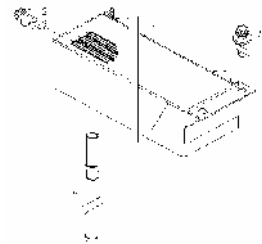

SECT. 19.1 FITTINGS FOR HYDRAULIC OIL COOLER

ENGINE MODEL	KIT # / CODE	REMARKS
B/F3-6L913/914	999-0022	FOR CLASS I COOLERS ONLY, BANJO BOLT AND FITTING TYPE
MISC. SEE REMARKS	999-0084	1 NPT FEMALE THREAD FOR BF6L913/C CLASS II AND III COOLERS ONLY
ALL 2011	999-0157 SPL	BANJO BOLT AND FITTING TYPE



SECT. 19.2 HYDRAULIC OIL PUMP, 8 CCM/REV

ENGINE MODEL	KIT # / CODE	ETL PAGE	REMARKS
ALL 1013/E / 2012	029-0663	05070190 05071914	MOUNTING AT PTO B , WITHOUT FITTINGS 05051844
ALL 2011	NO KIT		FOR DIN FLANGE ONLY (BOSCH PUMP) SEE SERPIC ETL 05051717

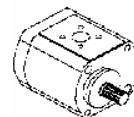

SECT. 19.3 HYDRAULIC OIL PUMP, 11 CCM/REV

ENGINE MODEL	KIT # / CODE	ETL PAGE	REMARKS
B/F4-6L 913/C/T/914 D914 L5, TCD914 L6	027-3885	05034475	INCLUDES METRIC FITTINGS WITH SQUEESE
	SPL		FERRULES
ALL 1013/E / 2012	029-2436	05070190	MOUNTING AT PTO B , WITHOUT FITTINGS
	SPL	05051844	05071677
ALL 2011	NO KIT		FOR DIN FLANGE ONLY (BOSCH PUMP) SEE SERPIC ETL 05051718

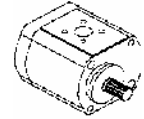

SECT. 19.4 HYDRAULIC OIL PUMP, 16 CCM/REV

ENGINE MODEL	KIT # / CODE	ETL PAGE	REMARKS
F3L-6L 914	027-1696	05003333 05034476	WITH METRIC FITTINGS W/ SQUEESE FERRULES 05042845
BF4/6L914 . TCD914 L6	027-3883	05034476	KIT
ALL 2011	NO KIT		FOR DIN FLANGE ONLY (BOSCH PUMP) SEE SERPIC ETL 05051719
ALL 1013/E / 2012	029-2437	05070190 05051844	MOUNTING AT PTO B , WITHOUT FITTINGS 05072170
1013	029-2375 SPL	05113110 05113188	BOSCH PTO "C" ONLY 05111116
TCD 2013	028-2387 SPL	05111484 05113188	BOSCH PTO "C" LOCATION ONLY 05111116
2012	029-2646 SPL	05113188 05113518	BOSCH PTO "C" LOCATION ONLY 05111636
TCD 2012	028-1843 SPL	05070190 05051844	BOSCH PTO "B" LOCATION ONLY 05072170
TCD 2013	028-1872 SPL	05070190 05051844	BOSCH PTO "B" LOCATION ONLY 05072170

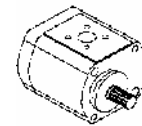

SECT. 20.2 HYDRAULIC OIL PUMP / AIR COMPRESSOR, DRIVE PARTS ONLY

ENGINE MODEL	KIT # / CODE	ETL PAGE	REMARKS
B/F3-6L913	027-0606 SPL	05003333 05003813	WITH BREATHER 05042845
F3-4L914	027-4334 SPL	05003813 05042845	DRIVING PARTS 05006870
F5-6L914	027-0611 SPL	05003813 05034283	WITH BREATHER 05042845
D914 L4 / L5	27-6361 SPL	05075002	DRIVING PARTS
BF4-6L914 / D914 L3/L6 TCD914 L6 ALL 1013/E	027-3880 029-0643 SPL	05003813 05070189 05072060	DRIVING PARTS SAE A2 FLANGE, 9T,16/32 DP SPLINE DRIVE, MOUNTED AT PTO POSITION A .
TCD 2013	028-1865 SPL	05070189 05072060	" " " "
2012 / TCD 2012 2V	028-1839 SPL	05070187 05070189	SAE A2 FLANGE, 9T,16/32 DP SPLINE DRIVE, (SAME AS 29-1386) MOUNTED AT PTO POSITION A .
TCD 2013 L06 4V	034-1860 SPL	05070189 05110875	SAE A2 FLANGE, 9T,16/32 DP SPLINE DRIVE, MOUNTED AT PTO POSITION A .
ALL 1013/E	029-0644	05072060 05070290	SAE B2 FLANGE,13T,16/32 DP SPLINE DRIVE, MOUNTED AT PTO POSITION A .
TCD 2013 / 2V	028-1866 SPL	05072060 05070290	" " " "
TCD2013 L6 4V	034-1698 SPL	05070290 05110875	" " " "
2012 / TCD 2012 2V	029-1628	05070187 05070290	SAE B2 FLANGE,13T,16/32 DP SPLINE DRIVE, (SAME AS 28-1840) MOUNTED AT PTO POSITION A .
ALL 1013/E / 2012 TCD 2013	029-1478 SPL	05070190 05051844	FOR BOSCH FLANGE, CONE TYPE, MOUNTED AT PTO LOCATION B . 05078195 (SAME AS 28-1844 & 28-1874)
ALL 2011	2200-3056 SPL	05074237 05079064 05074209 05074272 05074235	DIN FLANGE FOR BOSCH PUMPS DIN SPLINE DRIVE A17X14 WITH AIR COMPRESSOR MOUNTING PAD. RELATIVE TIMING BELT COVER ALSO REQUIRED
ALL 2011	2200-3055	05074237 05079110 05074209 05074273	SAE A2 HYDRAULIC PUMP DRIVE COMES WITH PROTECTIVE HOOD FOR PUMP RELATIVE TIMING BELT COVER ALSO REQUIRED. 05074235
ALL 2011	2200-3439	05079198	TIMING BELT COVER FOR PUMP DRIVE
ALL 2011	2200-3232	05074298	V-BELT GUARD FOR PUMP DRIVE
ALL 2011	2200-3233	05074297	V-BELT GUARD FOR ENGINE W/OUT PUMP DRIVE
ALL 2011	999-0945 SPL		HYD. PUMP FLANGE (SAE B SIZE, 4 HOLE) REQUIRES SAE 6.5 FLYWHEEL AND SAE 5 FLYWHEEL HOUSING PUMP SPLINE IS SAE B-B, 15 TOOTH MAX 50 HP

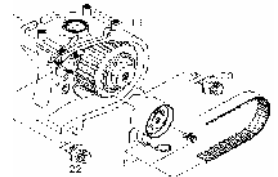
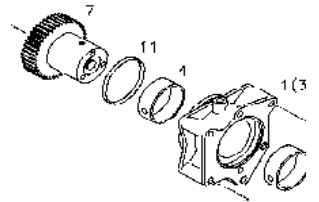
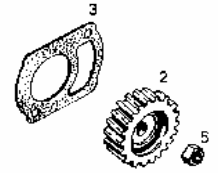

CONTINUED ON NEXT PAGE

SECT. 20.2 HYDRAULIC OIL PUMP / AIR COMPRESSOR, DRIVE PARTS ONLY

ENGINE MODEL	KIT # / CODE	ETL PAGE	REMARKS
ALL 2011	999-0943 SPL		REQUIRES SAE 8/10 FLYWHEEL AND INTERMEDIATE HOUSING PUMP FLANGE IS SAE B SIZE, 2 HOLE PUMP SPLINE IS SAE B-B, 15 TOOTH MAX 110 HP
ALL 2011	999-0944 SPL		REQUIRES SAE 8/10 FLYWHEEL AND INTERMEDIATE HOUSING PUMP FLANGE IS SAE B SIZE, 2 HOLE PUMP SPLINE IS SAE B-B, 13 TOOTH MAX 110 HP
BF6M1015/C	2201-1669 SPL	05069315 05076631	SAE B-2, 13T SPLINE DRIVE, PTO "A" 05079833
	2201-1671 SPL	05069316 05076631	SAE B-2, 13T SPLINE DRIVE, PTO "B" 05079833
	2201-1356 SPL	05069316 05079687	SAE C-2, 15T SPLINE DRIVE, PTO "B" 05079833
BF8M1015/C	2201-1670 SPL	05069296 05076631	SAE B-2, 13T SPLINE DRIVE, PTO "A" 05079833
	2201-1672 SPL	05069357 05076631	SAE B-2, 13T SPLINE DRIVE, PTO "B" 05079833
	2201-1276 SPL	05069357 05076630	SAE C-2, 15T SPLINE DRIVE, PTO "B" 05079833
1015	2201-1268 SPL	05069315 05076629	SAE B-2, 15T SPLINE DRIVE, PTO "A" 05079833
1015	2201-0648 SPL	05075851	GEAR CASE DRIVE PARTS FOR PTO "A"
TCD2015 V6/V8	2203-0201 SPL	05075588	PTO "A" DRIVE GEAR
TCD2015 V6/V8	2203-0202 SPL	05075589	PTO "B" DRIVE GEAR
2008 / 2009	3101-0299	05112074	DIN (FOR BOSCH HYD. PUMPS)
2008 / 2009	3101-0637 SPL	05112308	SAE A2 , SPLINE DRIVE 9T



REQUIRES ENGINE CONFIGURATION FOR PUMP DRIVES

SECT. 21.1 HYDRAULIC OIL PUMP FITTINGS

ENGINE MODEL	KIT # / CODE	REMARKS
ALL 1013 / 2012	999-0160	05003815 METRIC FITTINGS WITH SQUEESE FERRULES WITH 90 DEG. FLANGES
MISC. SEE REMARKS	999-0178	SAE 37 DEGREE FLARE TUBE FITTINGS, FOR USE WITH PUMPS UTILIZING KHD SUPPLIED METRIC FITTINGS.
MISC. SEE REMARKS	999-0179	SAE 37 DEGREE FLARE FLANGE FITTINGS, FOR USE WITH PUMPS SUPPLIED WITHOUT METRIC FITTINGS.

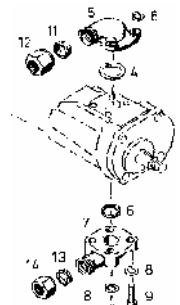

SECT.22.1 COOLANT TEMP SWITCHS AND SENSORS,

ENGINE MODEL	KIT # / CODE	ETL PAGE	REMARKS
ALL 1013/E(INT.& EXT.)	029-2595 SPL	05111201	SENDER WITH 113 DEG. CELCIUS SWITCH
All 2008 / 2009	3101-0469 SPL	05112262	NORMALLY CLOSED- OPENS AT 114 DEG. C AND CLOSES AT 105 DEG. C (GREEN)
All 2008 / 2009	3101-0470 SPL	05112050	NORMALLY OPEN- OPENS AT 114 DEG. C AND CLOSES AT 105 DEG. C (BLUE)
All 2008 / 2009	3101-0471 SPL	05112141	TEMP. SENSOR (WHITE)

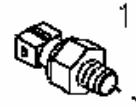

SECT. 22.5 CYL. HEAD TEMP. GAUGE (MANUAL)

ENGINE MODEL	KIT # / CODE	REMARKS
ALL 914	3367186	HAS 5 METER LENGTH CAPILLARY TUBE TO HEAD.

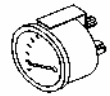

SECT. 22.6 CYLINDER HEAD TEMP (ELECTRIC)

ENGINE MODEL	KIT # / CODE	ETL PAGE	REMARKS
B/FL914 TIER I & II	027-1664 SPL	05113305	TEMP SENSOR ONLY (12V)
B/FL914 TIER I & II	027-4515 SPL	05013458 05113305	(12V) TEMP SENSOR & GAUGE 05050734, 05075399, 05076946
B/FL914 TIER I & II	027-4516 SPL	05013458 05113305	(24V) TEMP SENSOR & GAUGE 05050734, 05113032, 05076946
D914 L3-6 TIER III	027-8514 SPL	05113246	TEMP SENSOR ONLY (12V)
TCD914 L6	027-3451 SPL	05050734 05111203	TEMP SENSOR & GAUGE (12V) 05113206, 05013458
TCD914 L6	027-3448 SPL	05113305 05050734	TEMP SENSOR & GAUGE (24V) 05113205, 05111203

SECT. 23.3 OIL PRESSURE SENSOR, W/ WARNING CONTACT (WITHOUT GAUGE)

ENGINE MODEL	KIT # / CODE	ETL PAGE	REMARKS
B/F3-6L 913/C ALL914	027-0979	05050091 05063522	12/24 VOLT WITH 0.5 BAR SWITCH
ALL 1013/E	029-2668 SPL	05111202 05071706	12/24 VOLT WITH 0.5 BAR SWITCH
BFM 2012	029-2770 SPL	05111202 05071706	12/24 VOLT WITH 0.5 BAR SWITCH
TCD2012 / 2013	028-2023 SPL	05078371	
B/F3L-F4L/M2011 D/TD2011 F2L2011	2200-1668	05068119	ELECTRIC, WITHOUT GAUGE; .5 BAR SWITCH
	999-0586		SENSOR / SWITCH (WITH ANTI SMOKE KIT ONLY)
ALL 2008 / 2009	3101-0476	05112118	MAX PRESSURE 250 PSI



SECT. 24.1 OIL PRESSURE SWITCH FOR FIXED SPEED ENGINES

ENGINE MODEL	KIT # / CODE	ETL PAGE	REMARKS
B/F3-6L913/C ALL 914	027-1721	05113217	1301 - 1799 RPM, CLOSSES IN CASE OF FALLING PRESSURE (CLOSED) 2 BAR
B/F3-6L913/C ALL 914	027-1728	05113008	UP TO 1000 RPM,CLOSSES IN CASE OF FALLING PRESSURE (CLOSED) 1 BAR
B/F3-6L913/C/914 ALL 914	027-1729	05113007	1001 - 1300 RPM, CLOSSES IN CASE OF FALLING PRESSURE (CLOSED) 1.5 BAR
ALL 2008 / 2009	3101-0473 SPL	05112049	CLOSED 2-PIN (GREY)
	3101-0474 SPL	05112078	OPEN 1-PIN (YELLOW)
	3101-0475 SPL	05112261	OPEN 2-PIN (RED)



SECT. 24.2 OIL PRESSURE SWITCH, FOR VARIABLE SPEED ENGINES WITHOUT INDICATOR LIGHT, ALL 12-24 VOLT

ENGINE MODEL	KIT # / CODE	ETL PAGE	REMARKS
B/F3-6L913 ALL 914	027-0988 SPL	05037827 05075555	WITHOUT INDICATOR LIGHT
ALL 1013/E	029-1447 SPL	05111231	WITHOUT INDICATOR LIGHT
ALL 2011	2200-1660 SPL	05067636	WITHOUT INDICATOR LIGHT

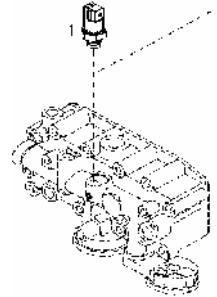

SECT. 24.4 OIL TEMP, SENSOR , W/ WARNING CONTACT ALL 12-24 VOLT

ENGINE MODEL	KIT # / CODE	ETL PAGE	REMARKS
B/F3-6L913/C/ ALL 914	027-1160	05016356	12/24 VOLT SENSOR ONLY, FOR GAUGE
B/F3-6L913/C/ ALL 914	027-1161 SPL	05016356 05113670 05111203	12 VOLT SENSOR WITH GAUGE 130 DEGREE CELSIUS SWITCH POINT
	027-1162 SPL	05016356 05113664 05111203	24 VOLT SENSOR WITH GAUGE 130 DEGREE CELSIUS SWITCH POINT
ALL B/FL2011	2200-2016 SPL	05069029	135 DEG. CELCIUS SWITCH POINT (SENSOR ONLY)
D/TD2011 L2,3,4/ I	2200-3922 SPL	05113694	140 DEG. CELCIUS SWITCH POINT (SENSOR ONLY)
ALL 2011 (WITH EMR 2)	2200-3689	05079193	SENSOR ONLY

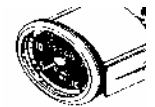
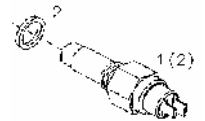

SECT. 25.1	TACHOMETER/SERVICE HOURMETER COMBO, MECHANICAL WITHOUT CAMSHAFT DRIVEN ANGLE DRIVE		REMARKS
ENGINE MODEL	KIT # / CODE		
B/F3-6L913/C/914	999-0051		KIT INCLUDES 1500 MM CABLE AND 0 - 3000 RPM TACHOMETER/HOURMETER ONLY. (HOURMETER NOT ACCURATE FOR VARIABLE SPEED ENGINES.)

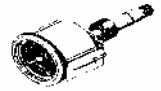

SECT. 25.2	TACHOMETER, ELECTRIC		REMARKS
ENGINE MODEL	KIT # / CODE		
ALL 913/914/2011/2012/2013	999-0086		12 VOLT, MUST HAVE ALTERNATOR WITH W TERMINAL



SECT. 25.3	ANGLE DRIVE, CAM DRIVEN, FOR MECHANICAL TACHOMETER			REMARKS
ENGINE MODEL	KIT # / CODE	ETL PAGE		
B/F3-6L913/C	027-1004	05003835	KIT	
		05016321	05063567	
BF6L 914C	027-2563	05003835	KIT	
		05016321	05069511	

SECT. 26.1	STARTING INDICATOR PANEL		12 VOLT	REMARKS
ENGINE MODEL	KIT # / CODE	ETL PAGE		
ALL 2011	999-0233	05068148		WITH MOUNTING BRACKET, 3 POSITION KEY SWITCH, INDICATOR LIGHTS FOR: ALT DISCHARGE, LUBE OIL TEMP PRESSURE (ENGINE MUST HAVE MAIN ENGINE HARNESS).

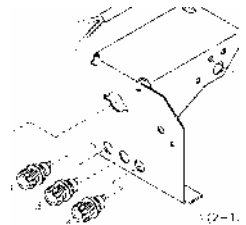

SECT. 27.1 ENGINE CONTROL PANEL (MECHANICAL) 12V / 24V

ENGINE MODEL	KIT # / CODE	REMARKS
914 / 1013 / 2011 / 2012 / 2013	999-0648	CONTROL PANEL WITH MTG. ISOLATORS MTG. BRACKET AND HARNESS SOLD SEPARATELY SEE BELOW. INCLUDES: OIL TEMP AND OIL PRESSURE GAUGES HOURMETER, TACHOMETER AND ENGINE PREHEAT WITH LED INDICATOR LIGHT. ENGINE MUST HAVE ELECTRIC OIL PRESSURE AND TEMP. SENDER/SWITCH MONITORS. 30 AMP PANEL MOUNTED FUSE
Mechanical Panel Repair Parts:		
300646 Key Switch		
300647 Replacement Key (Stamped 250)		
300651 Hourmeter		
300649 Temperature Gauge		
300648 Oil Gauge		
300650 Tachometer		
300601 Rubber Mtg. Isolator Kit		
300652 Isolator only		
913	999-0666	PANEL HARNESS
914	999-0915	PANEL HARNESS
2011	999-0658	PANEL HARNESS
BF4/6M2012C	999-0667	PANEL HARNESS
TCD2012 (MECH. GOV.)	999-1162	PANEL HARNESS
BF6M1013EC/ECP/FC	999-0665	PANEL HARNESS
1015	999-0668	PANEL HARNESS
ALL	999-0671	6 FOOT EXT. HARNESS
ALL	999-0727	20 FOOT EXT. HARNESS
F3L914 / D914 L3	999-0673	PANEL MTG. BRACKET (ENGINE MOUNTED)
BF6L914C / TCD914 L6	999-0655	PANEL MTG. BRACKET (ENGINE MOUNTED)
B/F4/5/6L/914 / D914 L4,5,6	999-0649	PANEL MTG. BRACKET (ENGINE MOUNTED)
B/F4L/M2011		
B/F2/3L/M2011	999-0657	PANEL MTG. BRACKET (ENGINE MOUNTED)
BF4/6M2012C	999-0672	PANEL MTG. BRACKET (ENGINE MOUNTED)
BF4/6M2012C	999-0639	PANEL MTG. BRACKET (FOR OPEN POWER UNIT)
BF4/6M2012C	999-0640	PANEL MTG. BRACKET (FOR ENCLOSED POWER UNIT)

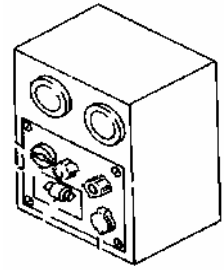

SECT. 28.1 ENGINE CONTROL PANEL (ELECTRONIC)

ENGINE MODEL	KIT # / CODE	REMARKS
TCD2012/2013/2015	999-0638	CONTROL PANEL WITH MTG. ISOLATORS. MTG. BRACKET AND HARNESS SOLD SEPARATELY (SEE BELOW)
Electronic Panel Repair Parts:		
300602 Rocker Switch		
300646 Key Switch		
300647 Replacement key (Stamped 250)		
300603 Fault Lamp		
300601 Rubber Mtg. Isolator Kit		
300652 Isolator only		
ALL EMR 2 / EMR 3 MVS ENGINES	999-0635	ELECTRONIC DISPLAY PANEL ONLY
ALL EMR 2 / EMR 3 MVS ENGINES	999-0636	ELECTRONIC PEDAL ONLY
TCD2012/2013	999-0656	PANEL HARNESS
TCD2015	999-0647	PANEL HARNESS
ALL EMR 3	999-0800	8 FOOT EXT. HARNESS
	999-0916	18 FOOT EXT. HARNESS
TCD2012/2013/2015	999-0672	PANEL MTG. BRACKET (ENGINE MOUNTED)
TCD2012/2013	999-0639	PANEL MTG. BRACKET (FOR OPEN POWER UNIT)
TCD2012/2013	999-0640	PANEL MTG. BRACKET (FOR ENCLOSED POWER UNIT)

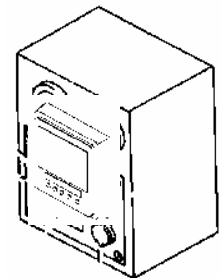

SECT. 30.0

ENGINE WIRING HARNESS

ENGINE MODEL	KIT # / CODE	ETL PAGE	REMARKS
BF4M 2012/C	029-4784 SPL	05076333 05078876	KIT
BF6M 2012/C	029-4812 SPL	05076375 05071744	KIT 05071743, 05078871

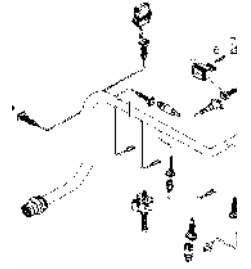

SECT. 30.1

EMR EXTENSION HARNESS

ENGINE MODEL	KIT # / CODE	ETL PAGE	REMARKS
ALL 2011	2200-3764 SPL	05079241 05113680	LENGTH 5 METER (for EMR2) 05072493, 05072513
ALL 1013 / 2012	029-6452 SPL	05072493 05072513	LENGTH 2.5 METER (for EMR2) 05076279, 05078406
ALL 1013 / 2012	029-6453 SPL	05072493 05072513	LENGTH 5 METER (for EMR2) 05076279, 05078442
TCD 2012 /2013	028-2874 SPL	05113747 05072513	LENGTH 5 METER (for EMR 3, EDC 16 controller) 05076279, 05113185
TCD 2012 /2013	028-2875 SPL	05113746 05072513	LENGTH 2.5 METER (for EMR 3, EDC 16 controller) 05076279, 05113185
TCD 2015	2203-0301 SPL	05069303 05072513	LENGTH 5 METER (for EMR 3, EDC 7 controller) 05076785, 05076786, 05079764
TCD 2015	2203-0302 SPL	05069303 05072513	LENGTH 2.5 METER (for EMR 3, EDC 7 controller) 05076785, 05076786, 05079763

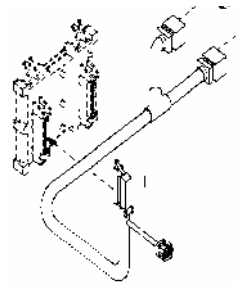

SECT. 30.2

LIFTING EYES

ENGINE MODEL	KIT # / CODE	ETL PAGE	REMARKS
B/F3-6L913/C/914	027-0935	05034243	HITCH LUG M16
ALL 1015	2201-1264 SPL	05023574 05067847	KIT M20
ALL 2011	2200-1260	05074361 05067562	KIT M12



SECT. 30.3

**EXHAUST MANIFOLD, OPENING AT FRONT
(BLOWER END)**

ENGINE MODEL	KIT # / CODE	ETL PAGE	REMARKS
F2L/M2011 / D2011 L2 / I	2200-0678 SPL	05074121	FOR ENGINES WITHOUT SIDE AIR DUCT
F3L/M2011 / D2011 L3 / I	2200-2307 SPL	05069191	FOR ENGINES WITHOUT SIDE AIR DUCT
F4L/M2011	2200-0680 SPL	05069182	FOR ENGINES WITHOUT SIDE AIR DUCT
D2011 L04 I	2200-4773 SPL	05069182 05114535 05114926	FOR ENGINES WITHOUT SIDE AIR DUCT
D/ TD/TCD 2011 L4 / I / W		*	*CONTACT DEUTZ APPLICATION ENGINEERING DEPARTMENT

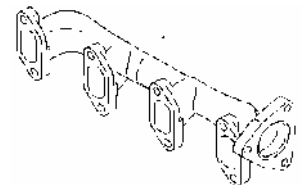

SECT. 30.4 EXHAUST MANIFOLD, OPENING AT REAR (FLYWHEEL END)

ENGINE MODEL	KIT # / CODE	ETL PAGE	REMARKS
F6L 913/914	027-0877	05037602	FOR ENGINES WITHOUT REAR MOUNTED FUEL TANK OR HYDRAULIC OIL COOLER
F3L 914	027-3134 SPL	05006828	FOR ENGINES WITHOUT REAR MOUNTED FUEL TANK OR HYDRAULIC OIL COOLER
F4L 913/914	027-3428 SPL	05004635	FOR ENGINES WITHOUT REAR MOUNTED FUEL TANK OR HYDRAULIC OIL COOLER
F3L/M2011	2200-0676 SPL	05074050	FOR ENGINES WITHOUT SIDE AIR DUCT
F4L/M2011	2200-0677 SPL	05069181	FOR ENGINES WITHOUT SIDE AIR DUCT
D2011 L2 / I	2200-0675 SPL	05074172	FOR ENGINES WITHOUT SIDE AIR DUCT
D2011 L3 / I	2200-2315 SPL	05069699	FOR ENGINES WITHOUT SIDE AIR DUCT
D/ TD/TCD 2011 L4 / I / W		*	*CONTACT DEUTZ APPLICATION ENGINEERING DEPARTMENT

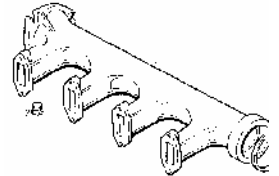

SECT. 31.1 EXHAUST MANIFOLD, OPENING AT CENTER OF ENGINE

ENGINE MODEL	KIT # / CODE	ETL PAGE	REMARKS
F5L 914	027-0856 SPL	05004351	UP OR DOWN
F6L 913/914	027-0874	05003614	UP OR DOWN
F4L 913/914	027-2313 SPL	05004633	UP OR DOWN
F3L 913/914	027-3131	05006825	UP OR DOWN
F6L 913 / 914	027-0873 SPL	05003613	UP, ENGINE W/AIR DUCT
F4L 913/914	027-2020	05004631	CENTER DOWN
F2L/M2011 / D2011 / L2 / I	2200-0633 SPL	05074171	DOWN
F3L/M2011 / D2011 / L3 / I	2200-0634 SPL	05074031	DOWN
F4L/M2011	2200-0635 SPL	05069186	DOWN, FLANGE AT 45 DEG. ANGLE
F2L/M2011 / D2011 / L2 / I	2200-0672	05074173	UP
F3L/M2011 / D2011 / L3 / I	2200-0673	05074030	UP
F4L/M2011	2200-0674	05069185	UP, FLANGE AT 45 DEG. ANGLE
D/ TD/TCD 2011 L4 / I / W		*	*CONTACT DEUTZ APPLICATION ENGINEERING DEPARTMENT

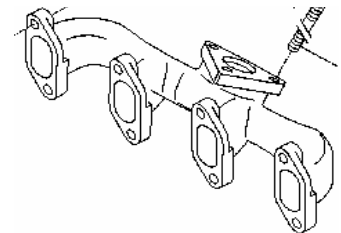

SECT. 31.2

EXH. MANIFOLD & MUFFLERS (FOR TURBO ENGINES)

ENGINE MODEL	KIT # / CODE	ETL PAGE	REMARKS
BF6L 913	027-2095 SPL	05006694 05037608	MANIFOLD FOR FRONT MOUNTED TURBO, WITH ELBOW. IF CHANGING LOCATION OF TURBO, PROPER OIL FEED AND DRAIN COMPONENTS MUST BE ORDERED.
BF6L 913	027-2096 SPL	05031830 05006694	MANIFOLD FOR CENTER MOUNT TURBO, WITH ELBOW, IF CHANGING LOCATION OF TURBO, PROPER OIL FEED AND DRAIN COMPONENTS MUST BE ORDERED.
BF4L 913SP/914	027-3896 SPL	05042296 05050292	EXH. OUTLET TO REAR FROM TURBO
BF4L 913SP/914	027-3604 SPL	05042296 05042282	90 DEGREE EXH. ELBOW MTD. ON TURBO
BF3-4L/M2011	999-0348		MUFFLER WITH ELBOW FLANGE: INCLUDING ALL MOUNTING HARDWARE AND RAIN CAP. ELBOW FLANGE HAS A FLEXIBLE STAINLESS STEEL BELLOWS IN THE CENTER. MUFFLER, INCLUDES HEAT SHEILD, MOUNTS HORIZONTALLY ON THE INTERMEDIATE HOUSING ON THE REAR OF THE ENGINE, PERPENDICULAR TO THE CRANKSHAFT WITH AN UP OUTLET AND CONDENSATION DRAIN HOLE.

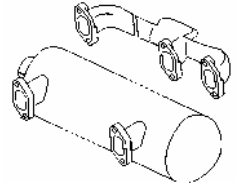

SECT. 31.3 EXHAUST EXTENSION, FLEXIBLE

ENGINE MODEL	KIT # / CODE	ETL PAGE	REMARKS
BF6L914/C	027-2443 SPL	05002346 05002348	INCLUDES: METAL PIPE 800 MM LONG, REDUCER
BF6M1015/C	2201-1484 SPL	05075584	FLEX PIPE WITH FLANGE 293MM LONG
BF8M1015/C	2201-0784 SPL	05068688	FLEX PIPES (2) WITH FLANGE 293MM LONG



SECT. 32.1 EXHAUST FLANGES AND ELBOWS

ENGINE MODEL	KIT # / CODE	ETL PAGE	REMARKS
F3-6L 913/914	027-0812	05034355 05068794	TRIANGLE COUNTERFLANGE WITH GASKET 05064509
BF4-6L 913/C/T/914	027-1591	05002097	TRIANGLE COUNTERFLANGE WITH GASKET
F3-4L 913	027-1906 SPL	05042184	MATING FLANGE & EXHAUST MANIFOLD (SUPPLIED LOOSE)
BF6M1013/E/C/P	029-1945 SPL	05002097 05078286	45 DEGREE ELBOW WITH FLANGE
BF6M1013/E/C/P	029-1949 SPL	05070507	TRIANGLE COUNTERFLANGE WITH GASKET
BF3-4L/M2011	999-0218		EXHAUST ELBOW FLANGE WITH FLEXIBLE STAINLESS STEEL BELLOWS IN THE CENTER, U-CLAMP, GASKET AND MOUNTING HARDWARE.
BF6M1015/C	2201-1482 SPL	05075581	ELBOW & FLANGE
BF8M1015/C	2201-0786 SPL	05068329	ELBOWS & FLANGE (2)
F2-4L/M2011	2200-0645	05064190	TRIANGLE FLANGE WITH GASKET
F2-4L/M2011	2200-0671	05067385	90 DEGREE ELBOW FOR MANIFOLD MUFFLER
BF4L/M2011	2200-0805	05063108	TRIANGLE FLANGE WITH GASKET

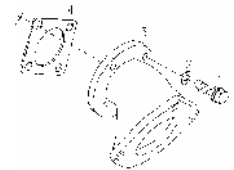

SECT. 33.1 EXHAUST MANIFOLD MUFFLER, OPENING AT REAR

ENGINE MODEL	KIT # / CODE	ETL PAGE	REMARKS
F6L 913/914	027-0878 SPL	05042089	W/ OUT MOUNTED FUEL TANK,
F4L 914	027-1996	05004578	W/ OUT MOUNTED FUEL TANK,
F3L 913/914	027-3135	05006829	W/ OUT MOUNTED FUEL TANK,
F5L 914	027-0863 SPL	05004357	W/ OUT MOUNTED FUEL TANK,
F2L/M2011 / D2011 / L2 / I	2200-0580 SPL	05051933	
F3L/M2011 / D2011 / L3 / I	2200-0581	05051795	
F4L/M2011	2200-0582	05051798	
D2011 L4 I / L4 W	*	*	*CONTACT DEUTZ APPLICATION ENGINEERING DEPARTMENT



SECT. 33.2 EXHAUST MANIFOLD MUFFLER, SIDE OPENING

ENGINE MODEL	KIT # / CODE	ETL PAGE	REMARKS
F2L/M2011	2200-0577 SPL	05051793 KIT	
F3L/M2011	2200-0578 SPL	05051796 KIT	
F4L/M2011	2200-0579 SPL	05051797 KIT	

SECT. 33.3 EXHAUST MANIFOLD MUFFLER, TOP OPENING

ENGINE MODEL	KIT # / CODE	ETL PAGE	REMARKS
F3L/M2011	2200-0799	05064321 EXHAUST SILENCER	
F4L/M2011	2200-0800 SPL	05063493 EXHAUST SILENCER	
F3L/M 2011	2200-0903 SPL	05064701 WITH SLIP OVER OUTLET PIPE	

SECT. 33.4 EXHAUST MANIFOLD MUFFLER, DOWN OUTLET

ENGINE MODEL	KIT # / CODE	ETL PAGE	REMARKS
F4L/M 2011	2200-1175 SPL	05063480 EXHAUST SILENCER	

SECT. 34.1 INTAKE MANIFOLD, SLIP-OVER, OPEN AT REAR

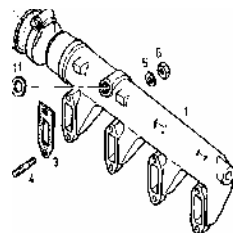
ENGINE MODEL	KIT # / CODE	ETL PAGE	REMARKS
F5L913 / 914	027-0906 SPL	05004360 NOT TO BE USED WITH MOUNTED FUEL TANK	
F6L 913/914	027-0913 SPL	05003491 NOT TO BE USED WITH MOUNTED FUEL TANK	
F4L 913/914	027-2061 SPL	05004645 NOT TO BE USED WITH MOUNTED FUEL TANK	
F3L 913/914	027-3164 SPL	05006834 NOT TO BE USED WITH MOUNTED FUEL TANK	

SECT. 34.3 INTAKE MANIFOLD ADAPTERS

ENGINE MODEL	KIT # / CODE	REMARKS	
2011	999-0368 SPL	2.75 DIAMETER	
2011	999-0369 SPL	3.0 DIAMETER	

SECT. 35.1 MOUNTS, FLEXIBLE, SINGLE BUFFER FRONT AND REAR

ENGINE MODEL	KIT # / CODE	ETL PAGE	REMARKS
B/F6L913/C/914	027-0767	05003305 05003716	CAST FOOT
B/F6L913/C/914	027-1815 SPL	05003305 05034408	STEEL FOOT, 68 SHORE
ALL 913/C/914	027-1827	05034408 05004623	STEEL FOOT, 68 SHORE
B/F4L 913/C/914	027-3052	05004623 05003716	CAST FOOT
BF4L 913/914	027-4430 SPL	05004623 05051540	NEW STEEL FOOT
B/F6L913/C/914	027-4796 SPL	05003305 05064322	NEW STEEL FOOT
ALL 1013/E/2012	029-1418	05070258 05074783 05074790	55 SHORE, 4x FEET ONLY, 2x REAR AT HOUSING 05071490, 05071491, 05077164
F5-6L 913/914 - B/F6L 914/C	027-0773	05003305 05020047	FLEX ENGINE MOUNTING
ALL 2011	2200-0419	05064221 05067599	50 SHORE, REAR MOUNTED ON ADAPT. HSNQ.
ALL 2011	2200-0565	05064224 05067600	65 SHORE, REAR MOUNTED ON ADAPT. HSNQ.
D3 / D2008L4	3101-0584 SPL	05112317 05112266	LOW LEVEL ENGINE MOUNTING
D3 / D4 / TD 2009L4	3101-0587 SPL	05112023 05112266	LOW LEVEL
D3 / D4 / TD 2009L4	3101-0586 SPL	05112192 05112266	HIGH LEVEL

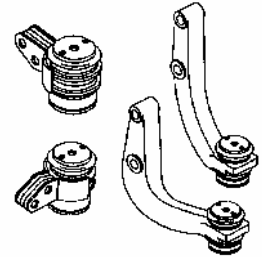

SECT. 35.2 MOUNTS, RIGID FRONT AND REAR

ENGINE MODEL	KIT # / CODE	ETL PAGE	REMARKS
BF4L 913/914	027-3056	05004623 05034218	BOLT ON FEET
ALL 1013/E	029-1412	05072424 05072473	4x FEET ONLY, 2x REAR AT HOUSING 05072994
ALL 1013/E	029-1569 SPL	05072424 05072994	(2) FRONT FEET ONLY
ALL 2011	2200-0416 SPL	05067596 05602803	REAR MOUNTED ON ADAPTOR HSNQ.
2011	2200-0641 SPL	05069138 05067594	FRONT RIGID
1015	2201-0573 SPL	05067916	RIGID FRONT & REAR
D3 / D4L2008	3101-0368 SPL	05112317	LOW LEVEL
D3 / D4 / TD 2009L4	3101-0371 SPL	05112023	LOW LEVEL
D3 / D4 / TD 2009L4	3101-0370 SPL	05112192	HIGH LEVEL



SECT. 35.3 OIL-TO-AIR CAB HEATERS / CONNECTIONS

ENGINE MODEL	KIT # / CODE	ETL PAGE	REMARKS
B/F3-6L913	027-1680 SPL	05050346 05064870	12 VOLT, HORNKOHL & WOLF
ALL 2011	2200-1534	05067710	CAB HEAT CONNECTIONS (SEE ETL 05067710)
ALL 2012	029-5052 SPL	05070228	CAB HEAT CONNECTIONS 22MM DIA. (FOR ENGINES W/OUT COMPRESSOR)
ALL 2012	029-5152 SPL	05078688 05078689	CAB HEAT CONNECTIONS 22MM DIA. (FOR ENGINES WITH COMPRESSOR)

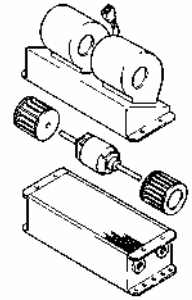

SECT. 36.1 OIL FILTERS, REMOTE MOUNTED

ENGINE MODEL	KIT # / CODE	ETL PAGE	REMARKS
	027-0315 SPL	05075108 05063570	1.5 LTR, SPIN ON, CONN./CABHEAT SYSTEM
B/FL 913/914	999-0183 SPL		3 FOOT #12 HOSE, AND 2.2 LTR FILTER
B/FL 913/914/1013	999-0184		3 FOOT #12 HOSE, AND 1.5 LTR FILTER
B/FL 913/914	999-0185 SPL		3 FOOT #12 HOSE, AND 1.0 LTR FILTER
F2-3L2011	999-0188 SPL		3 FOOT #10 HOSE, AND .6 LTR FILTER
B/F4L2011	999-0189 SPL		3 FOOT #12 HOSE, AND .6 LTR FILTER
2012 / 2013	029-5633 SPL	05078103 05078128	REMOTE LUBRIC. OIL FILTER / LINES / ADAPTER 05111122
1015 / 2015	2201-0577 SPL	05069379 05068335	REMOTE LUBRIC. OIL FILTER / ADAPTER / (NO OIL LINES)



SECT. 36.2 PULLEYS AND DRIVES FOR P.T.O. FRONT OF ENGINE

ENGINE MODEL	KIT # / CODE	ETL PAGE	REMARKS
F3-6L 914	999-0049		PULLEY, 2 GROOVE FOR USE WITH DOUBLE BELT DRIVE BLOWER
ALL FM 2011	2200-0536 SPL	05051755	PULLEY FOR AIR COMPRESSOR DRIVE 195.25 MM CRANK PULLEY
B/F2-4L2011	2200-0653	05051753	PULLEY FOR AIR COMPRESSOR DRIVE 162.2 MM CRANK PULLEY
B/F2-4L2011	2200-0654 SPL	05051985	PTO DRIVE HUB FOR HYD. OIL COOLER FAN 162.2 MM CRANK PULLEY

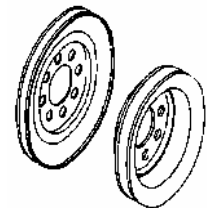

SECT. 36.3 SHUTDOWN, ELECTRIC, DIRECT LINKAGE RSV GOV. MOUNT

ENGINE MODEL	KIT # / CODE	REMARKS
BF4-6L 913/C	999-0174	RSV TYPE GOVERNOR OF INJECTION PUMP. 12 VOLT RIGHT HAND MOUNT, EXTERNALLY SWITCHED, 3 WIRE. MOUNTS DIRECTLY ON RSV TYPE GOVERNOR OF INJECTION PUMP. (SA 999-0211 LEVER IS REQUIRED FOR BF4L 913/C; SA 999-0215 IS REQUIRED FOR BF6L 913/C APPLICATION)
BF4-6L 913/C	999-0172	12 VOLT LEFT HAND MOUNT (SEE ABOVE DATA)
BF4-6L 913/C	999-0175	24 VOLT RIGHT HAND MOUNT, EXTERNALLY SWITCHED, 3 WIRE. MOUNTS DIRECTLY ON RSV TYPE GOVERNOR OF INJECTION PUMP. (SA 999-0211 LEVER IS REQUIRED FOR BF4L 913/C; SA 999-0215 IS REQUIRED FOR BF6L 913/C APPLICATION)
BF4-6L 913/C BF4L 913/C	999-0173 999-0211 SPL	24 VOLT LEFT HAND MOUNT, (SEE ABOVE DATA) LEVER REQUIRED WHEN APPLYING RIGHT HAND RSV MOUNT SHUTDOWN TO BF4L 913/C ENGINE
BF6L 913/C	999-0215	LEVER REQUIRED WHEN APPLYING RIGHT HAND RSV MOUNT SHUTDOWN TO BF6L 913/C ENGINE
F6L 913	999-0343 SPL	12V LEFT HAND MOUNT. EXTERNALLY SWITCHED 3 WIRE. MOUNTS DIRECTLY ON RSV TYPE GOVERNOR OF INJECTION PUMP.

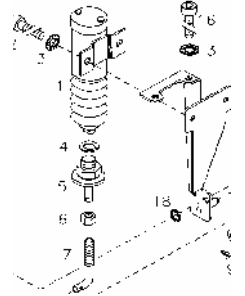

SECT. 37.1 SHUTDOWN, ELECTRIC, DIRECT LINKAGE (ENERGIZED TO RUN)

ENGINE MODEL	KIT # / CODE	ETL PAGE	REMARKS
BF6L 913/C	027-4495 SPL	05034422 05006572	24 V, FOR AMBIENT TEMP BELOW 130 DEG C 05067866, 05079416, 05075301
2012	029-1439 SPL	05076191 05076186	24 VOLT
ALL 1013/E	029-1441 SPL	05076189 05076186	24 VOLT



SECT. 37.2 SHUTDOWN, ELECTRIC, DIRECT LINKAGE (ENERGIZED TO RUN)

ENGINE MODEL	KIT # / CODE	ETL PAGE	REMARKS
F6L 913	027-4482 SPL	05034420 05067866	24 VOLT, AMBIENT TEMP BELOW 130 DEG C 05075301
F6L 913	027-0450 SPL	05034420 05067866	12 VOLT, AMBIENT TEMP BELOW 80 DEG C 05075300
F3/5L914	027-7436 SPL	05079469	24 VOLT, FOR AMBIENT TEMP BELOW 125 DEG C
F4/6L914	027-7174 SPL	05075408	24 VOLT, FOR AMBIENT TEMP BELOW 125 DEG C
BF4-6L914/C/TCD914 L6	027-7039	05075285 05075408	24 VOLT, FOR AMBIENT TEMP BELOW 125 DEG C
D914 L05	027-8729	05116050 05072237	24 VOLT, FOR AMBIENT TEMP BELOW 125 DEG C
D914 L4 / L6	027-8727	05116048 05072237	24 VOLT, FOR AMBIENT TEMP BELOW 125 DEG C

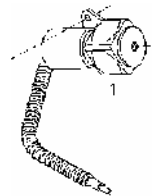

SECT. 37.3 SHUTDOWN, ELECTRIC, FUEL SHUTOFF VALVE (ENERGIZED TO RUN)

ENGINE MODEL	KIT # / CODE	ETL PAGE	REMARKS
B/F3-6L913/C	027-3580	05113019	12 VOLT
B/F3-6L913/C	027-3581	05042763	24 VOLT



SECT. 38.1 SHUTDOWN, MECHANICAL, ACTUATED BY BLOWER V-BELT FAILURE

ENGINE MODEL	KIT # / CODE	ETL PAGE	REMARKS
F6L 913	027-0493 SPL	05003783 05034247 05075147	FOR SINGLE-BELT BLOWER DRIVE W/OUT IDLER PULLEY,
F6L 913	027-0494	05003801 05034247 05050267	FOR DOUBLE-BELT BLOWER DRIVE W/OUT IDLER PULLEY,
BF6L 913/C	027-2322	05034247 05006572 05006639	FOR DOUBLE-BELT BLOWER DRIVE; W/OUT IDLER PULLEY, 05042276
F3L 913	027-2909 SPL	05034247 05006784 05075146	FOR SINGLE-BELT BLOWER DRIVE; W/OUT IDLER PULLEY,
F3L 913	027-2910	05034247 05006785 05051849	FOR DOUBLE-BELT BLOWER DRIVE; W/OUT IDLER PULLEY,
F4L 913	027-2914 SPL	05034247 05004530 05075146	FOR SINGLE-BELT BLOWER DRIVE; W/OUT IDLER PULLEY,
F4L 913	027-2915	05034247 05004532 05051849	FOR DOUBLE-BELT BLOWER DRIVE; W/OUT IDLER PULLEY,

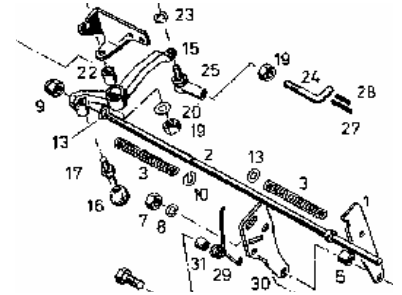

SECT. 39.1 SHUTDOWN MONITOR, V-BELT FAILURE SWITCH, 3- PRONG

ENGINE MODEL	KIT # / CODE	ETL PAGE	REMARKS
B/F3-6L 913/C/F5-6L914	027-0489	05031763 05031765 05034247	NORMALLY CLOSED, CAN BE REWIRED TO BE NORMALLY OPEN; 05075147

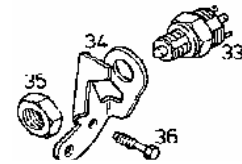

SECT. 39.2 SPEED CONTROL, FINE ADJUSTMENT

ENGINE MODEL	KIT # / CODE	ETL PAGE	REMARKS
B/F3-6L 913/C	027-0411 SPL	05003543	FOR ENGINES NOT EQUIPPED W/ MECHANICAL, MANUAL OR SOLENOID SHUTDOWN
B/FL914 / D914 L3, L5	027-7200 SPL	05079593	FOR ENGINES NOT EQUIPPED W/ MECHANICAL, MANUAL OR SOLENOID SHUTDOWN
B/F3-6L 913/C	027-0413	05003544	FOR ENGINES EQUIPPED W/ MECHANICAL, MANUAL OR SOLENOID SHUTDOWN
B/FL914 / D914 L4 D/TCD914 L6	027-7201 SPL	05075394	FOR ENGINES EQUIPPED W/ MECHANICAL, MANUAL OR SOLENOID SHUTDOWN
913	027-2333 SPL	05006575	FINE ADJUSTMENT
BF6L 913/C	027-2334 SPL	05006576	FOR ENGINES EQUIPPED W/ MECHANICAL, MANUAL OR SOLENOID SHUTDOWN
ALL 1013/E	029-1443 SPL	05070164 05071912	WITHOUT MOUNTING BRACKET, WHICH IS STANDARD.
ALL 1015	2201-1035 SPL	05068399 05068340 05068400	MANUAL FINE SPEED

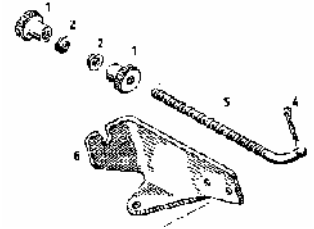

SECT. 39.3 SPEED CONTROL, HAND THROTTLE MOUNTED ON ENGINE

ENGINE MODEL	KIT # / CODE	ETL PAGE	REMARKS
F3L914 / D914 L3	027-7425 SPL	05079547	SPEED ADJUSTMENT
F4L914 / D914 L4	027-7426 SPL	05079550	SPEED ADJUSTMENT
F5L914 / D914 L5	027-7424 SPL	05079475	SPEED ADJUSTMENT
F6L 914 / D914 L6	027-7186 SPL	05075421	SPEED ADJUSTMENT
BF6L914	027-7187 SPL	05079326	SPEED ADJUSTMENT
BF6L914C	027-7188 SPL	05075422	SPEED ADJUSTMENT
TCD914 L6	027-8568 SPL	05113310	SPEED ADJUSTMENT
F4L913	027-2824	05032691	SPEED ADJUSTMENT
F6L 913	027-1239	05032694	SPEED ADJUSTMENT
BF6L 913/C	027-4200	05023345 05032682	SPEED ADJUSTMENT
ALL 2011	2200-3442 SPL	05079021 05077853	(90 DEG. ANGLE LEVER)
D914 L3 / TCD914 L6	027-0412	05075169	WITH BOWDEN CABLE
1015	2201-1035 SPL	05068399 05068340	WITH BOWDEN CABLE 05068400

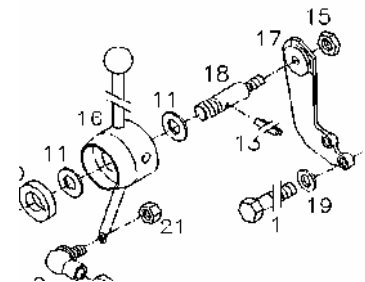

SECT. 40.1 STARTER, 12 VOLT

ENGINE MODEL	KIT # / CODE	ETL PAGE	REMARKS
913 / 914	027-5597 SPL	05069739	3 KW
ALL 1013	029-0917 SPL	05070666 05071107	3 kw 05072571, 05072725
1013/2012/2013	029-4196 SPL	05070197 05078342	3.0 KW DUST PROTECTED W/OUT SHIELD
1013/2012/2013	029-6343 SPL	05078342 05077966	3.0 KW DUST PROTECTED WITH HEAT SHIELD 05070157
ALL 2011	2200-3222	05079244 05079277	2.6 KW
ALL 2011	2200-2460 SPL	05079247	4.0 KW (12 VOLT HEAVY DUTY)
ALL 2011	2200-3499 SPL	05079245 05079277	12V 2.6 KW, DUST PROTECTED W/OUT SHIELD
ALL 2011	2200-3500 SPL	05069189 05079245	12V 2.6 KW, DUST PROTECTED WITH HEAT SHIELD 05079277
ALL 2011	2200-2027 SPL	05069189	(HEAT SHIELD ONLY)
All 2008 / 2009	3101-0353 SPL	05112024	12V 2.0 KW

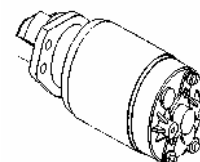

SECT. 40.2 STARTER 24 VOLT

ENGINE MODEL	KIT # / CODE	ETL PAGE	REMARKS
913 / 914	027-0457	05069740	4.0 KW
BF6L 913/C	027-0461 SPL	05003655 05027024	5.4 KW
1013/2012/2013	029-3632 SPL	05070157 05078343	4.0 KW DUST / WATER PROTECTED
ALL 2011	2200-3501 SPL	05079246 05079278	4.0 KW DUST PROTECTED
TCD2015 V6/V8	2203-0828 SPL		6.6 KW DUST AND WATER PROTECTED

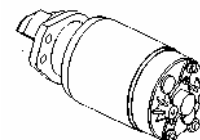

SECT. 40.3 STARTING AID, INTAKE PREHEAT, FLAME TYPE

ENGINE MODEL	KIT # / CODE	ETL PAGE	REMARKS
B/F3-6L 913/C	027-0823	05116002 05003471	12 VOLT; INTAKE OPENING @ BLOWER END 05003735, 05091015, 05034248, 05003743, 05075190, 05075022
B/F3-6L 913/C	027-0824	05003471 05005912	24 VOLT; INTAKE OPENING @ BLOWER END 05031677, 05003743, 05075297, 05063952, 05075305
F6L 913	027-0833 SPL	05003471 05003735	12 VOLT; INTAKE OPENING @ FLYWHEEL END 05091015, 05003804, 05034248, 05003743 05075190, 05075022
F4L 913	027-3294 SPL	05003471 05003735	12 VOLT; INTAKE OPENING @ FLYWHEEL END 05091015, 05034248, 05006962, 05003743 05075190, 05075022
BF4L913	027-5736 SPL	05003471 05034248	12 VOLT, W/DIAPHRAGM FUEL LIFT PUMP 05050239, 05069742
BF4L 913	027-3663 SPL	05003471 05003735	12 VOLT: INTAKE OPENING AT FLYWHEEL END 05091015, 05034248, 05050239, 05003743, 05075190, 05075022
F3L914 / D914 L3	027-7359	05034248 05063953	12 VOLT, INTAKE OPENING BLOWER END 05079590

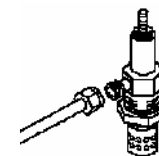

CONTINUED ON NEXT PAGE

CHECK WITH DC-NORCROSS FOR LEAD TIME ON ITEMS WITH 'SPL' STOCK CODE

REV. 01/2009

SECT. 40.3

STARTING AID, INTAKE PREHEAT, FLAME TYPE

ENGINE MODEL	KIT # / CODE	ETL PAGE	REMARKS
F4L914 / D914 L4	027-7360	05034248 05063953	12 VOLT, INTAKE OPENING BLOWER END 05079552
F5L914 / D914 L5	027-7510	05034248 05079906	12 VOLT, INTAKE OPENING BLOWER END 05063953
F4L914 / D914 L4	027-7361 SPL	05034248 05063953	12 VOLT, INTAKE OPENING FLYWHEEL END 05079553
F5L914 / D914 L5	027-7511	05063954 05075297	24 VOLT, INTAKE OPENING BLOWER END 05079906
F6L914 / D914 L6	027-7217	05034248 05063953	12 VOLT, INTAKE OPENING BLOWER END 05113352
F6L914 / D914 L6	027-7105 SPL	05075297 05063954	24 VOLT, INTAKE OPENING BLOWER END 05113352
F6L914 / D914 L6	027-7219 SPL	05034248 05063953	12 VOLT: INTAKE OPENING AT FLYWHEEL END 05113353
F6L914 / D914 L6	027-7218 SPL	05075297 05063954	24 VOLT: INTAKE OPENING AT FLYWHEEL END 05113353
BF4L914	027-7466	05034248 05063953	12 VOLT CENTER TURBO 05079591
BF6L914C / TCD914 L6	027-7150	05034248 05063953	12 VOLT 05113354
BF6L914C / TCD914 L6	027-7149 SPL	05075297 05063954	24 VOLT 05113354
BF4L 914	027-7467	05075297 05063954	24 VOLT (CENTER TURBO) 05079591
BF6M 1015/C/CP	2201-2552 SPL	05067834 05075709	W/OUT TIMER CONTROL UNIT 05077234, 05078388
BF6M 1015/C/CP	2201-0664 SPL	05067834 05075709	WITH TIMER CONTROL UNIT 05072905, 05079628
BF8M 1015/C/CP	2201-2553 SPL	05067834 05075710	W/OUT TIMER CONTROL UNIT 05077234, 05078388
BF8M 1015/C/CP	2201-0667 SPL	05067834 05075710	WITH TIMER CONTROL UNIT 05072905, 05079628
TCD2015 - V6	2203-0279 SPL	05078609 05079722	W/OUT TIMER CONTROL UNIT 05079827
TCD2015 - V8	2203-0280 SPL	05078609 05079722	W/OUT TIMER CONTROL UNIT 05079828

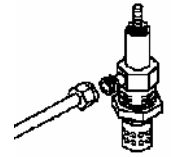

SECT. 40.5

STARTING AID, INTAKE MANIFOLD PREHEATER (FLANGE STYLE)

ENGINE MODEL	KIT # / CODE	REMARKS
ALL 2012	999-0161	MANIFOLD HEATER CONTROL UNIT & RELAY, 12V MANIFOLD HEATER CONTROL UNIT & RELAY, 24V
ALL 2012	999-0165	
	SPL	

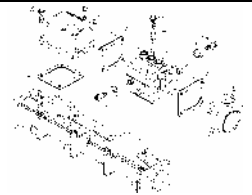

SECT. 41.1

STARTING AID, PENCIL TYPE GLOW PLUG

ENGINE MODEL	KIT # / CODE	ETL PAGE	REMARKS
BF4M1013/E/C	029-2685 SPL	05051776 05070225 05071693	12 VOLT, INCLUDES STARTING ACCESSORIES, AND AMBIENT TEMP. SENSOR CONTROL UNIT. 05071707, 05111190, 05074490
BF4M1013/E/C	029-2686 SPL	05037960 05070279 05071693	24 VOLT, INCLUDES STARTING ACCESSORIES, AND AMBIENT TEMP. SENSOR CONTROL UNIT. 05071707, 05074490, 05111090

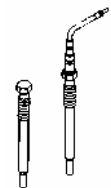

CONTINUED ON NEXT PAGE

CHECK WITH DC-NORCROSS FOR LEAD TIME ON ITEMS WITH 'SPL' STOCK CODE

REV. 01/2009

SECT. 41.1 STARTING AID, PENCIL TYPE GLOW PLUG

ENGINE MODEL	KIT # / CODE	ETL PAGE	REMARKS
BF4M1013/E/C	029-2687 SPL	05070225 05071693 05071707	12 VOLT, WITHOUT STARTING ACCESSORIES, AND AMBIENT TEMP. SENSOR CONTROL UNIT. 05111190, 05074490
BF4M1013/E/C	029-2688 SPL	05070279 05071693 05071707	24 VOLT, WITHOUT STARTING ACCESSORIES, AND AMBIENT TEMP. SENSOR CONTROL UNIT. 05074490, 05111090
BF6M1013/E/C/P	029-2698 SPL	05051776 05070225 05071694	12 VOLT, INCLUDES STARTING ACCESSORIES, AND AMBIENT TEMP. SENSOR CONTROL UNIT. 05071708, 05111190, 05074490
BF6M1013/E/C/P	029-2699 SPL	05037960 05070279 05071694	24 VOLT, INCLUDES STARTING ACCESSORIES, AND AMBIENT TEMP. SENSOR CONTROL UNIT. 05071708, 05074490, 05111090
BF6M1013/E/C/P	029-2700 SPL	05070225 05071694 05071708	12 VOLT, WITHOUT STARTING ACCESSORIES, AND AMBIENT TEMP. SENSOR CONTROL UNIT. 05111190, 05074490
BF6M1013/E/C/P	029-2701 SPL	05070279 05071694 05071708	24 VOLT, WITHOUT STARTING ACCESSORIES, AND AMBIENT TEMP. SENSOR CONTROL UNIT. 05074490, 05111090

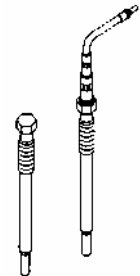

SECT. 41.2 STARTING AID, MANIFOLD HEATER PLUG

ENGINE MODEL	KIT # / CODE	ETL PAGE	REMARKS
ALL 2011	2200-1890	05063365 05063419	12 VOLT, WITHOUT STARTING ACCESSORIES, W/O AMBIENT TEMP. SENSOR CONTROL UNIT, WITH SINGLE GLOW PLUG.
ALL 2011	2200-1905	05063365 05063419 05074134	12 VOLT, WITHOUT STARTING ACCESSORIES, WITH AMBIENT TEMP. SENSOR CONTROL UNIT, WITH SINGLE GLOW PLUG.
ALL 2011	2200-1907	05068224 05074136	12 VOLT, WITHOUT STARTING ACCESSORIES, WITH AMBIENT TEMP. SENSOR CONTROL UNIT, WITH DUAL GLOW PLUG.
B/FL/FM 2011	2200-1908 SPL	05068225 05074129	24 VOLT 2 GLOW PLUGS, W/TIMER RELAY

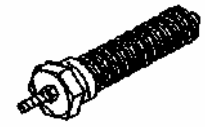

SECT. 41.3 STARTING ACCESSORIES, 12 VOLT

ENGINE MODEL	KIT # / CODE	ETL PAGE	REMARKS
B/F3-6L 913/C/914 TCD914 L6	027-1365 SPL	05002414 05003736 05003725	FOR INTAKE PREHEAT; KIT INCLUDES: KEY SWITCH, KEY, LIGHTS, CONNECTORS 05016187, 05022913
B/F3-6L 913/C/914 TCD914 L6	027-1367	05002414 05003736 05003725	FOR W/O INTAKE PREHEAT; KIT INCLUDES: KEY SWITCH, KEY, LIGHTS, CONNECTORS 05004427, 05016186
ALL 914	027-1368 SPL		24 VOLT
ALL 1013/E	029-1430 SPL	05070159 05051776	FOR WITH OR WITHOUT INTAKE PREHEAT; INCL: KEY SWITCH, KEY, CHARGE INDICATOR LIGHT,
ALL 2011	2200-1887	05051775 05068223	FOR WITH OR W/O INTAKE PREHEAT; INCLUDES KEY SWITCH, 2 KEYS, SPADE CONNECTORS, OIL TEMPERATURE INDICATOR LIGHT AND BULB.

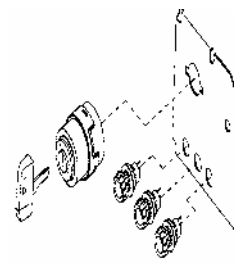

SECT. 42.1 STUBSHAFT, FRONT MOUNT

ENGINE MODEL	KIT # / CODE	REMARKS
ALL 2011	999-0176	3" X .375" KEYWAY 1.5" DIAMETER SHAFT
ALL 913 / 914	999-0177	3" X .5" KEYWAY, 1.875" DIAMETER SHAFT



SECT. 42.2 STUBSHAFT, REAR MOUNT

ENGINE MODEL	KIT # / CODE	REMARKS
ALL 913 / 914	999-0028	FOR SAE 10/11.5 FLYWHEEL 6.5 X .37 KEYWAY, 1.75 DIAMETER SHA
1013	999-0028	FOR SAE 8/10-10/11.5 FLYWHEEL
2011	999-0028	FOR SAE 10 FLYWHEEL
2011	999-0026 SPL	FOR SAE 6.5 FLYWHEEL, 5 X .37 KEYWAY 1.5 DIAMETER SHAFT

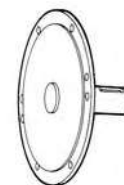

SECT. 42.4 V-BELT GUARDS

ENGINE MODEL	KIT # / CODE	ETL PAGE	REMARKS
BF4L 913/914	027-6433 SPL	05069745	FOR ENGINES WITH BOSCH ALTERNATORS
BF6L 913/914/C / TCD914 L6	027-2595	05027699 05027716	FOR ENGINES WITHOUT MOUNTED OIL BATH AIR CLEANER SA 27-7362.
F6L914	027-2596 SPL	05027716	FOR ENGINES WITHOUT MOUNTED OIL BATH AIR CLEANER (STEEL)
F6L914 / D914 L6	027-0595 SPL	05027699 05027700	ALUMINUM
F3-4L 913/914	027-6432 SPL	05069744	FOR ENGINES WITH BOSCH ALTERNATORS (STEEL)
F3-4L 913/914 / D914 L3, L4	027-2931 SPL	05068795	FOR ENGINES WITH BOSCH ALT. WELDED SHEET METAL. (STEEL)
GBF6L913C/BF6L 914/C	999-0397		BELT GUARD KIT
ALL FL 2011	2200-0248	05063178	FOR ENGINES WITHOUT HYDRAULIC PUMP AND OR AIR COMPRESSOR
ALL FL 2011	2200-0783	05063179	FOR ENGINES WITH HYDRAULIC PUMP AND OR AIR COMPRESSOR
D2011 L2 I /L3 I/L4 I	2200-3232	05074298	FOR ENGINES WITHOUT HYDRAULIC PUMP
TD2011 L4 I	2200-4944 SPL	05119055	FOR ENGINES WITH HYDRAULIC PUMP DRIVE
TD2011 L4 I	2200-4945 SPL	05119051	FOR ENGINES WITHOUT HYDRAULIC PUMP DRIVE
D2008 L3 D2008 L4	3101-0691 3101-0689		FOR FAN DIAMETER 380MM BORG WARNER FOR FAN DIAMETER 380MM BORG WARNER
D2009 L3	3101-0687	05112296 05112497	FOR FAN DIAMETER 380MM BORG WARNER
D2009 L4	3101-0685	05112296 05112465	FOR FAN DIAMETER 380MM BORG WARNER WITH SIDE DRIVE COVER AND GUARD PLATES
D2009 L4	3101-0686	05112465	FOR FAN DIAMETER 380MM BORG WARNER WITH SIDE DRIVE COVER

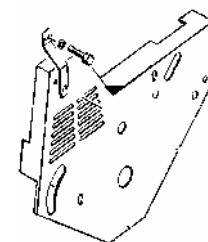

SECT. 42.5

WIRING COUNTERPLUGS

ENGINE MODEL	KIT # / CODE	ETL PAGE	REMARKS
ALL 914	999-0904 SPL		COUNTER PLUG FOR ENGINE WIRING HARNESS
ALL 913	2200-0499 SPL	05051778	COUNTER PLUG FOR ENGINE WIRING HARNESS
ALL 1013/E	029-1342 SPL	05071488	COUNTER PLUG, FOR ENG W/ WIRING HARNESS
ALL 1013/E	029-1554 SPL	05071488 05071489	FOR ENGINE HARNESS AND GLOW PLUG
ALL 913/2011	2200-1650 SPL	05074150	COUNTER PLUG FOR FUEL SOLENOID
ALL 2011	2200-1659	05068115	COUNTER PLUG FOR ENGINE WIRING HARNESS
1015	2201-1254 SPL	05069272 05069303	FOR ENGINE WIRING HARNESS & GLOW PLUG
ALL 2012	029-5103 SPL	05076330 05076331	COUNTER PLUG KIT, FOR WIRING HARNESS 05077699, 05077234
ALL 2012	029-5106	05070621 05071486	COUNTER PLUG KIT, SENSORS & SWITCHES 05076331, 05077699, 05077234
ALL 2012	029-4817 SPL	05076330	COUNTER PLUG ONLY (HARNESS TO PANEL)



SECT. 42.6

ENGINE HEATERS

ENGINE MODEL	KIT # / CODE	REMARKS
1013 / 2012	030-3154	CONNECTS TO OIL COOLER HOUSING 750 WATT 120 VOLT W/ 5 FOOT CORD.
2011	030-3152	OIL PAN PRE-HEATER 120 VOLT 150 WATT (FOR 48MM OIL PAN PLUG OPENING)
2011	030-3153	OIL PAN PRE-HEATER 120 VOLT 150 WATT (FOR 22MM OIL PAN PLUG OPENING)
913/914	003-2205	OIL PAN HEATER (CLAMP ON) UNIVERSAL
2008 / 2009	030-0235 SPL	BLOCK HEATER 110 VOLT 400 WATT

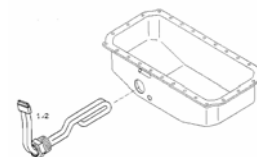

SECT. 43.2

OIL PANS / OIL DIPSTICKS

ENGINE MODEL	KIT # / CODE	ETL PAGE	REMARKS
BF4M 2012/C	029-4525 SPL	05113579 05113580	CAST IRON OIL PAN 05072823, 05078908
BF4M 2012/C	029-4681 SPL	05070793 05077680	DIPSTICK FOR CAST IRON OIL PAN 05074909
BF4M 2012/C BF6M 2012/C	029-4680 SPL	05072983 05077680	EXTENDED DIPSTICK FOR STD. 4530 OIL PAN 05074909

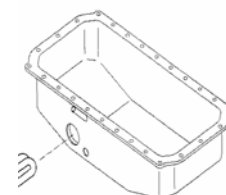

SECT. 43.3

OIL DRAIN VALVES

ENGINE MODEL	KIT # / CODE	REMARKS
1011F / 2011/ 2012 / 1013 / 2013	9991208	18 MM OIL DRAIN VALVE 1.5 THREAD W/NIPPLE
ALL 2008/2009	9991209	14 MM OIL DRAIN VALVE 1.5 THREAD W/NIPPLE
ALL 1015 / 2015	9991210	30 MM OIL DRAIN VALVE 1.5 THREAD W/NIPPLE
ALL 914	9991211	22 MM OIL DRAIN VALVE 1.5 THREAD W/NIPPLE



SECT. 43.4

RADIATORS (POWER PAC COOLING PACKAGES)

ENGINE MODEL	KIT # / CODE	REMARKS
BF4M2012	999-2088	RADIATOR, EXPANSION TANK FAN SHROUD, FAN GUARD COMPLETE BRACKET KIT, MOUNTING HARDWARE, HOSES
BF4M2012C	999-2089	RADIATOR, EXPANSION TANK CHARGE AIR COOLER, FAN SHROUD FAN GUARD, HOSES CHARGE AIR COOLER PIPING KIT MOUNTING HARWARE
BF6M2012C	999-2090	RADIATOR, EXPANSION TANK, CHARGE AIR COOLER, FAN SHROUD FAN GUARD, COMPLETE BRACKET KIT, MOUNTING HARDWARE, HOSES CHARGE AIR COOLER PIPING KIT
TCD2012 L4 2V / 2M	999-0948	RADIATOR, EXPANSION TANK, CHARGE AIR COOLER, FAN SHROUD FAN GUARD, COMPLETE BRACKET KIT, MOUNTING HARDWARE, HOSES CHARGE AIR COOLER PIPING KIT
TCD2012 L6 2V	999-0949	RADIATOR, EXPANSION TANK, CHARGE AIR COOLER, FAN SHROUD FAN GUARD, COMPLETE BRACKET KIT, MOUNTING HARDWARE, HOSES CHARGE AIR COOLER PIPING KIT
TCD2013 L6 2V	999-0950	RADIATOR, EXPANSION TANK, CHARGE AIR COOLER, FAN SHROUD FAN GUARD, COMPLETE BRACKET KIT, MOUNTING HARDWARE, HOSES CHARGE AIR COOLER PIPING KIT
TCD2013 L6 4V	999-0951	RADIATOR, EXPANSION TANK, CHARGE AIR COOLER, FAN SHROUD FAN GUARD, COMPLETE BRACKET KIT, MOUNTING HARDWARE, HOSES CHARGE AIR COOLER PIPING KIT, BELT GUARD
D/TD2011 L4	999-0957	COMPLETE RADIATOR ASSY, OVERFLOW BOTTLE COMPLETE BRACKET KIT, MOUNTING HARDWARE, HOSES
TCD2011 L4	999-0958	COMPLETE RADIATOR ASSY, CHARGE AIR COOLER , PIPING OVERFLOW BOTTLE, COMPLETE BRACKET KIT MOUNTING HARDWARE, HOSES
D/TD/TCD2011 L4	999-0961 999-0962	PUSHER FAN PULLER FAN
BF4M2012 / C / TCD2012 L4 M	999-0906 999-0907	PUSHER FAN PULLER FAN
BF6M2012C / TCD2012 L4 2V	999-0908 999-0909	PUSHER FAN PULLER FAN
TCD2012 L6 2V	999-0911 999-0912	PUSHER FAN PULLER FAN
TCD2013 L6 2V	999-0914 999-0910	PUSHER FAN PULLER FAN
TCD2013 L6 4V	999-0913 999-0910	PUSHER FAN PULLER FAN

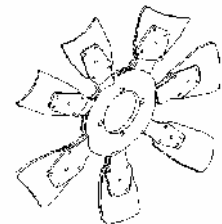
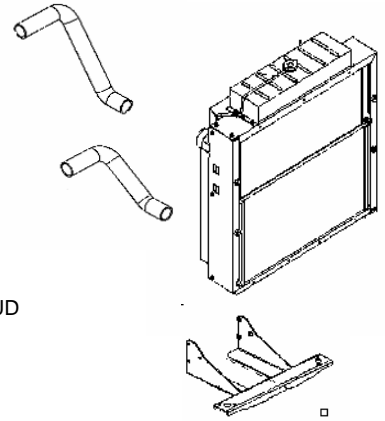

SECT. 43.5

RADIATORS (SPECIAL APPLICATION, NOT POWER PAC)

ENGINE MODEL

KIT # / CODE

REMARKS

BF4M2012

999-0494

RADIATOR (AKG) WITH HYDRAULIC OIL COOLER
REQUIRES PIPE KIT 999-0493 (UNLESS CUSTOMER SUPPLIES)

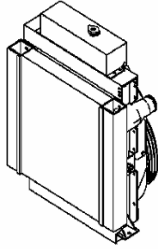

THE FOLLOWING KITS ARE REQUIRED UNLESS ENGINE CONFIGURATION MATCHES BOM #6630

REQUIRES SUCTION FAN KIT 29-2478
REQUIRES FAN HEIGHT OF 220mm / SPEED RATIO 1 : 1
REQUIRES LATERAL THERMOSTAT COOLANT OUTLET ELBOW 29-4573
REQUIRES FAN ADAPTER (77mm) KIT 29-4581

IN CASE OF PU BASE ENGINE, NEED THE FOLLOWING KITS

REQUIRES FAN ADAPTER (77mm) KIT 29-4581
REQUIRES SUCTION FAN KIT 29-2478
REQUIRES LATERAL THERMOSTAT COOLANT OUTLET ELBOW 29-4573

BF4M2012C

999-0488

RADIATOR W/ HYD. OIL COOLER AND CHARGE AIR COOLER
REQUIRES RAD. PIPE KIT 999-0492 (UNLESS CUSTOMER SUPPLIES)
REQUIRES CAC PIPE KIT 999-0491 (FOR ETC CTR. LOW REAR EXHAUST)
REQUIRES CAC PIPE KIT 999-0490 (FOR ETC CTR. HIGH REAR EXHAUST)

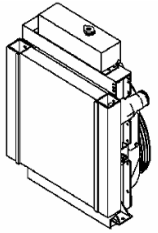

THE FOLLOWING KITS ARE REQUIRED UNLESS ENGINE CONFIGURATION MATCHES BOM #6564

REAR INTAKE MANIFOLD WITH HEATING FLANGE
REQUIRES SUCTION FAN KIT 29-2483
REQUIRES FAN HEIGHT OF 220mm / SPEED RATIO 1 : 1
REQUIRES FAN ADAPTER (77mm) KIT 29-4581
REQUIRES LATERAL THERMOSTAT COOLANT OUTLET ELBOW 29-4573

INCASE OF PU BASE ENGINE

LONGER PIPE BETWEEN CAC & ETC WILL BE REQUIRED (TO BE SUPPLIED-BY CUSTOMER).

TCD 2012 L4
(INCLUDES SUCTION FAN)

999-0374

RADIATOR W/ HYD. OIL COOLER AND CHARGE AIR COOLER
REQUIRES RAD. PIPE KIT 999-0379 (UNLESS CUSTOMER SUPPLIES)
REQUIRES CAC PIPE KIT 999-0378 (FOR ETC CTR.HIGH REAR EXHAUST)

SECT. 43.5.1 1015 OPEN POWER UNIT COMPONENTS

ENGINE MODEL	KIT # / CODE	REMARKS
BF6M1015	999-0425 SPL	RADIATOR
BF6M1015CP	999-0431 SPL	RADIATOR
BF8M1015C/CP	999-0432 SPL	RADIATOR
BF6M1015/CP/BF8M1015C/CP	999-0463 SPL	BELT GUARD
BF6M1015/CP/BF8M1015C/CP	999-0422 SPL	SWAY BRACE
BF6M1015	999-0427 SPL	SUCTION FAN 1800 RPM / 2100 RPM
BF6M1015CP	999-0440 SPL	SUCTION FAN 1800 RPM
BF8M1015C/CP	999-0435 SPL	SUCTION FAN 1800 RPM / 2100 RPM
BF6M1015CP	999-0428 SPL	SUCTION FAN 2100 RPM
BF6M1015	999-0444 SPL	PUSHER FAN 1800 RPM
BF6M1015CP	999-0461 SPL	PUSHER FAN 1800 RPM
BF6M1015CP	999-0452 SPL	PUSHER FAN 2100 RPM
BF8M1015C/CP	999-0462 SPL	PUSHER FAN 1800 RPM / 2100 RPM
BF6M1015	999-0426 SPL	COOLING PIPES
BF6M1015CP	999-0430 SPL	COOLING PIPES
BF8M1015C/CP	999-0433 SPL	COOLING PIPES
BF6M1015CP	999-0429 SPL	CAC PIPES
BF8M1015C/CP	999-0434 SPL	CAC PIPES
BF6M1015/CP/BF8M1015C/CP	999-0253 SPL	VIBRATION MOUNTS
BF6M1015	999-0423 SPL	FUEL FILTER ASSEMBLY
BF6M1015CP/BF8M1015C/CP	999-0436 SPL	FUEL FILTER ASSEMBLY
BF6M1015/CP	999-0424 SPL	SKID BASE
BF8M1015C/CP	999-0399 SPL	SKID BASE
BF6M1015/CP	999-0394 SPL	AIR CLEANER STAND
BF8M1015C/CP	999-0400 SPL	AIR CLEANER STAND
BF6M1015	999-0287 SPL	AIR CLEANER
BF6M1015CP	999-0439 SPL	AIR CLEANER
BF8M1015C/CP	999-0420 SPL	AIR CLEANER
BF6M1015/CP	999-0393 SPL	REAR FEET ASSY.
BF8M1015C/CP	999-0398 SPL	REAR FEET ASSY.

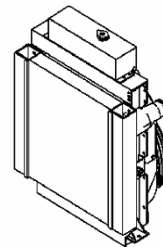
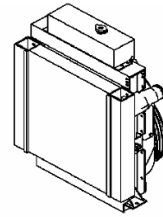

SECT. 43.6

FAN DRIVES

ENGINE MODEL	KIT # / CODE	ETL PAGE	REMARKS
BF4M 2012/C	029-4608 SPL	05076334 05077668	290 MM HIGH, RATIO 1:1.0 05078810, 05113595
BF6M 2012/C	029-4609 SPL	05076334 05076321	290 MM HIGH, RATIO 1:1.0 05078810, 05077668, 05113595
BF4M 2012/C	029-4614 SPL	05076379 05078810	360 MM HIGH, RATIO 1:1.0 05077668, 05113595
BF6M 2012/C	029-4615 SPL	05076379 05076321	360 MM HIGH, RATIO 1:1.0 05078810, 05077668, 05113595



SECT. 43.7

**CLUTCH PTO
(SEE NEXT PAGE FOR SPECIFICATIONS)**

PTO TYPE	KIT #	PTO MODEL #	REMARKS
TWIN DISC PTO	999-8119	CX106P501	FITS SAE #5 HSG. / SAE 6.5" FLYWHEEL
TWIN DISC PTO	999-8120	CX108P401	FITS SAE #4 HSG. / SAE 8" FLYWHEEL
TWIN DISC PTO	999-8121	CX110P301	FITS SAE #3 HSG. / SAE 10" FLYWHEEL (72MM PILOT)
TWIN DISC PTO	999-8122	SP111P301	FITS SAE #3 HSG. / SAE 11.5" FLYWHEEL
TWIN DISC PTO	999-8123	SP211P301	FITS SAE #3 HSG. / SAE 11.5" FLYWHEEL
TWIN DISC PTO	999-8124	SP314P101	FITS SAE #1 HSG. / SAE 14" FLYWHEEL (80MM PILOT)
NACD PTO	999-0520	411294AM	FITS SAE #5 HSG. / SAE 6.5" FLYWHEEL
NACD PTO	999-0521	431026AM	FITS SAE #4 HSG. / SAE 8" FLYWHEEL
NACD PTO	999-0522	436003AMI	FITS SAE #3 HSG. / SAE 10" FLYWHEEL (62MM PILOT)
NACD PTO	999-0306	434510AM	FITS SAE #3 HSG. / SAE 11.5" FLYWHEEL (72MM PILOT)
NACD PTO	999-0307	434845AM	FITS SAE #3 HSG. / SAE 11.5" FLYWHEEL

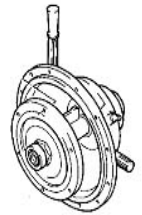

CLUTCH PTO SPECIFICATIONS

TWIN-DISC CLUTCH				APPLICATION DUTY CLASSIFICATION								APPROX. WEIGHT		SHAFT			
				MAX TORQUE CLASS 1		CLASS 2		CLASS 3		CLASS 4							
DEUTZ SA Kit	TWIN-DISC MODEL #	SAE Hsg #	SAE Fly #	Lb-Ft	Nm	Hp	kW	Hp	kW	Hp	kW	Lbs.	kg.	in.	mm	in.	mm
999-8119	CX106P501	5	6.5	159	216	40.0	29.9	27.0	20.1	20.0	14.9	53	24.1	3.5	88.9	1.44	36.5
999-8120	CX108P401	4	8	230	312	61.0	45.5	41.0	30.6	31.0	23.1	72	32.7	6	152	1.75	44.5
999-8121	CX110P301	3	10	328	445	96.0	71.6	64.0	47.8	48.0	35.8	115	52.3	5.63	143	2.25	57.2
999-8122	SP111P301	3	11.5	455	617	124.0	92.5	82.0	61.2	62.0	46.3	141	64.1	6.5	165	2.25	57.2
999-8123	SP211P301	3	11.5	909	1233	247.0	184.3	165.0	123.1	124.0	92.5	155	70.5	6.5	165	2.5	63.5
999-8124	SP314P01	1	14	2430	1793	564.0	420.9	376.0	280.6	282.0	210.4	425	192.0	10	254	3.94	100.0

NACD CLUTCH				APPLICATION DUTY CLASSIFICATION								APPROX. WEIGHT		SHAFT			
				MAX TORQUE CLASS 1		CLASS 2		CLASS 3		CLASS 4							
DEUTZ SA Kit	NACD MODEL #	SAE Hsg #	SAE Fly #	Lb-Ft	Nm	Lb-Ft	Nm	Lb-Ft	Nm	Lb-Ft	Nm	Lbs.	kg.	in.	mm	in.	mm
999-0520	411294AM	5	6.5	83	113	41.7	56.5	27.8	37.7	20.8	28.3	53	24.1	3.5	88.9	1.44	36.5
999-0521	431026AM	4	8	140	190	70.0	95.0	46.7	63.3	35.0	47.5	72	32.7	6.0	152	1.75	44.5
999-0522	436003AM	3	10	307	416	153.3	208.1	102.2	138.7	76.7	104.0	115	52.3	5.5	140	2.25	57.2
999-0306	434510AM	3	11.5	467	633	233.3	316.6	155.6	211.1	116.7	158.3	141	64.1	6.5	165	2.25	57.2
999-0307	434845AM	3	11.5	933	1266	466.7	633.2	311.1	422.1	233.3	316.6	155	70.5	6.5	165	2.5	63.5

Rating Class examples

- Class 1** Centrifugal pumps, hydraulic pumps, irrigation pumps
- Class 2** Line shafts with uniform load, gensets, elevator drives
- Class 3** Blowers & fans, centrifugal compressors, multi-cylinder piston pumps, conveyor drives, feeder drives
- Class 4** Crane & hoist drives, chipper drives, tub grinders, multi-cylinder recip compressors, mud pumps, crusher drives

Applicability

For engine model applicability, consult the appropriate engine technical data sheet to obtain peak torque and/or rating information. Consult engine specification to determine the flywheel and housing configuration.

For side load limits and additional technical information, please consult the following manufacturer documents:

- Twin-Disc Bulletin 308-S
- NACD Power Take-Off Service Manual

PTO kits do not include mounting hardware